

E500 E700 & E900

Operator Manual

Version 2.14 (English)



1	Preface	7
1.1	Disclaimer	7
1.2	Trademarks	7
1.3	Compliance statements	8
1.4	Limited Warranty	8
1.5	About this manual	9
1.6	Internet usage	9
1.7	Copyright	9
2	Device overview	11
2.1	Check the contents	11
2.2	Accessories	12
2.3	Other products	12
3	Introduction	13
3.1	Screen types	13
3.2	Display orientation	15
3.3	First run	15
3.4	Disclaimer	16
3.5	The Home screen	17
3.5.1	Quick Access page	18
	Screenset selection panel	18
	Shortcuts	19
	Brightness control	20
3.5.2	Settings	21
	Navigating through settings	22
3.5.3	Warnings	23
3.5.4	Profiles	24
3.5.5	Logbook	24
3.5.6	Navigation	25
4	Basic operation	26
4.1	User interface	26
4.1.1	Keyboard input	26
4.1.2	Spin controls	26
4.1.3	Sliders	27
4.1.4	Checkbox	27
4.1.5	Gesture mode	27
4.2	Preferences	28
4.2.1	Display	28
4.2.2	Time & Date	29
4.2.3	Units	29
4.2.4	Internal beeper	29
4.2.5	Language	29
4.2.6	Reset Profile	29
4.3	IAssist	30
4.3.1	Setup IAssist	31
	Screen assistant menu	31
	Speed source transition	31
4.4	Warnings	32
4.4.1	Type of warnings	32
4.5	Limits & Alarms	33
	Depth alarms	33

Fuel alarms	33
Speed Alarms	34
No wake zone	34
Engine alarms	34
Other alarms	34
4.6 Vessel Parameters	35
Anchor watch radius	35
Cruising speed	35
Fuel tank volume	35
Echo fuel data	35
4.7 Fuel	36
Calculated fuel	36
Measured fuel	36
4.8 Anchor watch	37
4.9 No wake zone	38
5 Dashboards	39
5.1 Fuel economy	40
5.1.1 Centre gauge –fuel or battery state of charge	41
5.1.2 Inner gauge – RPM indication	42
5.1.3 Left and right gauge	42
5.2 Speed	42
5.3 Compass	43
5.4 Trim	44
5.5 Rudder	44
5.6 Depth	45
5.7 Fluids	45
5.8 Battery	46
6 Charts	47
6.1 The Chart Screen	47
6.1.1 Panning the chart	49
6.1.2 Displaying information about chart items	49
6.1.3 Open sea map charts	50
6.1.4 Navionics charts	50
6.1.5 Selecting maps data	51
6.2 Chart settings	52
7 Navigating	54
7.1 Selecting a destination	54
7.2 Selecting destination from favourites	55
7.3 Navigating to destination	56
7.4 Deleting route	57
7.5 Adding intermediate points	57
7.6 Delete intermediate point	58
7.7 Reaching destination	58
8 Trip	59
User trip	59
Logbook trip	59
Owner trip	60
9 Audio	61
9.1 Audio source	62
9.2 Volume control	62

9.3	Audio Mixer	62
9.4	Folder Browser	63
9.5	Current station/music information	63
9.6	Play controls	64
10	Connectivity	65
10.1	Wi-Fi access points	65
10.2	Wi-Fi Configuration	65
10.3	SOFTWARE update	66
11	Customizing your system	67
11.1	Floating boxes	67
11.1.1	Creating new floating box	67
	Dropdown menu	68
	Selecting parameter	68
	Adding parameter	69
	Delete a parameter	69
11.1.2	Moving the floating box	69
11.1.3	Edit floating box	70
11.1.4	List of parameters	70
11.2	Screens and Screensets	71
11.2.1	Screensets	71
	Select active screenset	71
	New screenset	72
	Edit screenset	72
	Delete screenset	72
11.2.2	Screens	73
	Create new screen	73
	Edit screen	73
	Delete screen	74
11.3	Profiles	75
	Select profile	75
	Add profile	75
	Lock profile	76
	Edit profile	76
	Delete profile	76
11.4	NMEA2000 Network	77
11.4.1	Connected devices	77
11.4.2	Data sources	77
11.4.3	Device calibration	78
	Engine calibration	78
	Depth calibration	79
	Fluid level calibration	79
	Ruder angle calibration	80
	Jogwheel calibration	80
	Battery calibration	80
11.5	Password	81
12	Owner mode	82
12.1	Restore point	82
	Save restore point	82
	Restore device	83
12.2	Statistics	83

12.3	Owner mode pin	83
13	Using jogwheel	84
14	Maintenance	85
	Cleaning the display unit	85
	Creating debug report	85
15	Specifications	86
15.1	Mechanical/Environmental specification	86
	E500 Mechanical/Environmental	86
	E500 Electrical	86
	E500 Interfaces	86
	E700 Mechanical/Environmental	87
	E700 Electrical	87
	E700 Interfaces	87
	E900 Mechanical/Environmental	88
	E900 Electrical	88
	E900 Interfaces	88
15.2	Dimensional drawings	89
15.3	Supported data	92
16	REVISION HISTORY	94

1 Preface

1.1 Disclaimer

As LXNAV is continuously improving this product, we retain the right to make changes to the product at any time that may not be reflected in this version of the manual. Please contact us if you require any further assistance. It is the owner's sole responsibility to install and use the equipment in a manner that will not cause accidents, personal injury or property damage. The user of this product is solely responsible for observing safe boating practices.

LXNAV DISCLAIMS ALL LIABILITY FOR ANY USE OF THIS PRODUCT IN A WAY THAT MAY CAUSE ACCIDENTS, DAMAGE OR THAT MAY VIOLATE THE LAW.

Governing Language: This statement, any instruction manuals, user guides and other information relating to the product may be translated to another language. In the event of any conflict between any translations of the documentation, the English language version will be the official version.

LXNAV reserves the right to change or improve their products and to make changes in the content of this material without obligation to notify any person or organization of such changes or improvements.

Do NOT rely on this device as your primary source of navigation.

User is responsible for using official charts and prudent methods for safe navigation. User assumes all liability for operation and associated risks. Navigation feature is based on electronic chart information. Data does not ensure obstacle and bottom clearance. Navigation and fuel functions are used for general planning only. They do not replace common navigational practices and should never be used as the only source of navigation.

Navigation may calculate routes that pass over land or shallow water.

Use visual sightings, and steer to avoid land, shallow water, and other dangerous objects.

1.2 Trademarks

Navionics® is a registered trademark of Navionics, Inc.

FUSION-Link™ Marine Entertainment Standard™ is a registered trademark of FUSION Electronics Ltd.

NMEA® and NMEA 2000® are registered trademarks of the National Marine Electronics Association.

SD™ and microSD™ are trademarks or registered trademarks of SD-3C, LLC in the United States, other countries or both.

Bluetooth® is a registered trademark of Bluetooth SIG, Inc.

OpenSeaMap is an open source, worldwide project to create a free nautical chart. All the data in the OpenStreetMap database, including OpenSeaMap data, is under the ODbL. The chart tiles are under the "Creative Commons Attribution Share-Alike 2.0" license. In short, the license stipulates that any use of OSM data is permissible, even for commercial purposes, however OpenStreetMap must be attributed and the resulting data must be released under the same license.

Qt is a registered trademark of The Qt Company Ltd. and its subsidiaries.

1.3 Compliance statements

This equipment complies with:

- CE under 2014/30/EU Directive

1.4 Limited Warranty

This E500/E700 product is warranted to be free from defects in materials or workmanship for two years from the date of purchase. Within this period, LXNAV will, at its sole option, repair or replace any components that fail in normal use. Such repairs or replacement will be made at no charge to the customer for parts and labour, provided that the customer pays for shipping costs. This warranty does not cover failures due to abuse, misuse, accident, or unauthorized alterations or repairs.

THE WARRANTIES AND REMEDIES CONTAINED HEREIN ARE EXCLUSIVE AND IN LIEU OF ALL OTHER WARRANTIES EXPRESSED OR IMPLIED OR STATUTORY, INCLUDING ANY LIABILITY ARISING UNDER ANY WARRANTY OF MERCHANTABILITY OR FITNESS FOR A PARTICULAR PURPOSE, STATUTORY OR OTHERWISE. THIS WARRANTY GIVES YOU SPECIFIC LEGAL RIGHTS, WHICH MAY VARY FROM STATE TO STATE.

IN NO EVENT SHALL LXNAV BE LIABLE FOR ANY INCIDENTAL, SPECIAL, INDIRECT OR CONSEQUENTIAL DAMAGES, WHETHER RESULTING FROM THE USE, MISUSE, OR INABILITY TO USE THIS PRODUCT OR FROM DEFECTS IN THE PRODUCT.

Some states do not allow the exclusion of incidental or consequential damages, so the above limitations may not apply to you. LXNAV retains the exclusive right to repair or replace the unit or software, or to offer a full refund of the purchase price, at its sole discretion. SUCH REMEDY SHALL BE YOUR SOLE AND EXCLUSIVE REMEDY FOR ANY BREACH OF WARRANTY.

To obtain warranty service, contact your local LXNAV dealer or contact LXNAV directly.

1.5 About this manual

This manual is a reference guide for operating Ex00 series devices. It assumes that all equipment is installed and configured, and that the system is ready to use. The manual assumes that the user has basic knowledge of navigation, nautical terminology and practices. Important text that requires special attention from the reader is emphasized as follows:



A yellow triangle is shown for parts of the manual which should be read very carefully and are important when operating the Ex00 device.



Notes with a red triangle describe procedures which are critical and may result in loss of data or any other critical situation.



A bulb icon is shown when a useful hint is provided to the reader.

This manual is written for software version 2.14. The manual is continually updated to match new software releases. The latest available manual version can be downloaded from marine.lxnav.com.

1.6 Internet usage

Some features in this product use an internet connection to perform data downloads and uploads. Internet usage via a connected mobile phone may require large data usage. Your service provider may charge you based on the amount of data you transfer. Charge rates may change, depending on the regions. If you are unsure, contact your service provider to confirm rates and restrictions.

1.7 Copyright

Copyright © 2020 LXNAV. All rights reserved.

2 Device overview

2.1 Check the contents

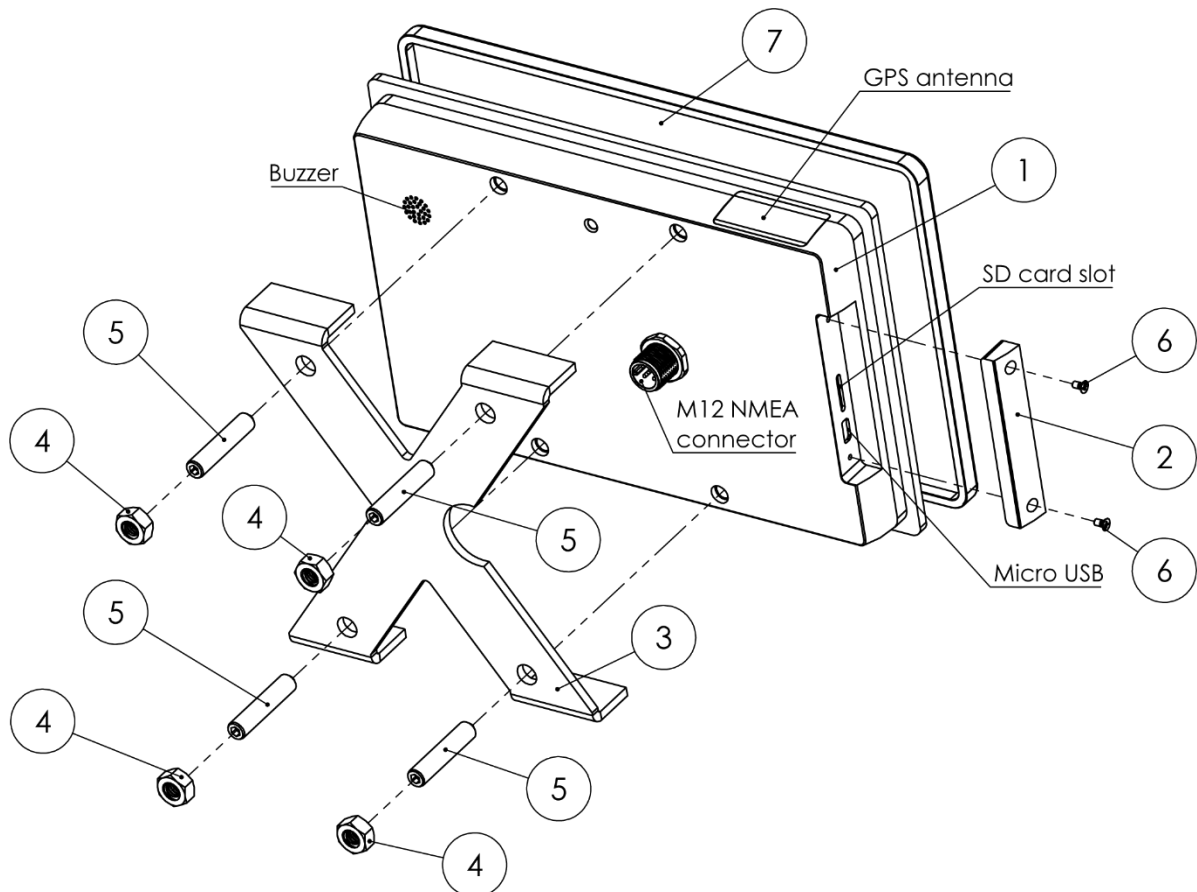

- 1 Ex00 device
- 2 SD card and USB port cover
- 3 aluminium cross for panel mounting
- 4 M6 nut (4 pcs)
- 5 Screw M6 x 30mm DIN916 (4 pcs)
- 6 Screw M2 x 4 DIN965 (4 pcs)
- 7 Ex00 panel mount screen cover

2.2 Accessories

Part number	Part description
COVERx	Panel Mount Sun Cover
MOUNTx	Panel Mount Kit
M12-CAN-POWER-TEE-5	Power Cable

2.3 Other products

This manual may refer to the following LXNAV products:

Product number	Product description
LX-JOG-WHEEL	Jogwheel
LX-SMART-GPS	SmartGPS
SMART_SHUNT-N2K-x00A	SmartSHUNT
SMART-EMU-N2K	SmartEMU
FLUID-N2K-E	Fluid level converter

3 Introduction

LXNAV E-series devices are multifunctional 5", 7" or 9" multi touch display. They all feature an extremely bright display up to 1800 units. Display includes a gesture sensor, which allows the user to operate basic functionality even without touching it. There are three different ways of operating units: multifunctional touchscreen, a gesture mode or an externally connected jogwheel.

The device reads data from the NMEA2000 network. Using IAssisty, it will show only what is relevant to a specific point in time. Audible and visible alarms are issued when the vessel operator's attention is required.

3.1 Screen types

There are three different screen types available on the device. Some of the screens are optional and based on the option purchased. Some of them require external hardware connections.



In this manual, you will find the description a device with full options, which requires also external hardware is described.

The **dashboard screen** shows one big numerical parameter in the center of the screen. Additional gauges for various engine parameters are drawn. The user can add also numerical values to the screen. Compass heading can be shown on the top at the screen. An example of such a dashboard screen is shown on a picture below.

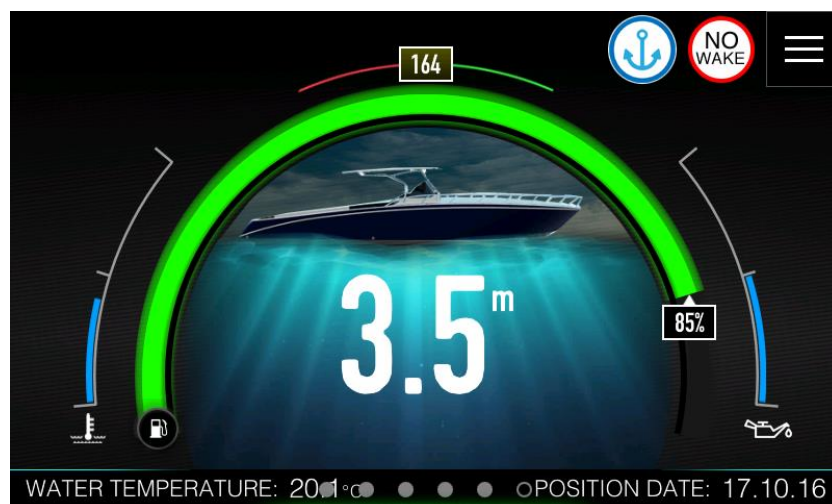

The dashboard screen is also used for IAssisty function. The idea of dashboard screen is to show to the operator the right information at the right time. A smart logic is built-in device to choose right screen for a given situation. There is no need for the operator to search for requested parameter. A single most important value is shown on the centre of the screen.

The **Chart screen** displays your boat position relative to land and other chart objects. On the chart panel you can plan and navigate to a selected destination or you can mark your favourite spots.

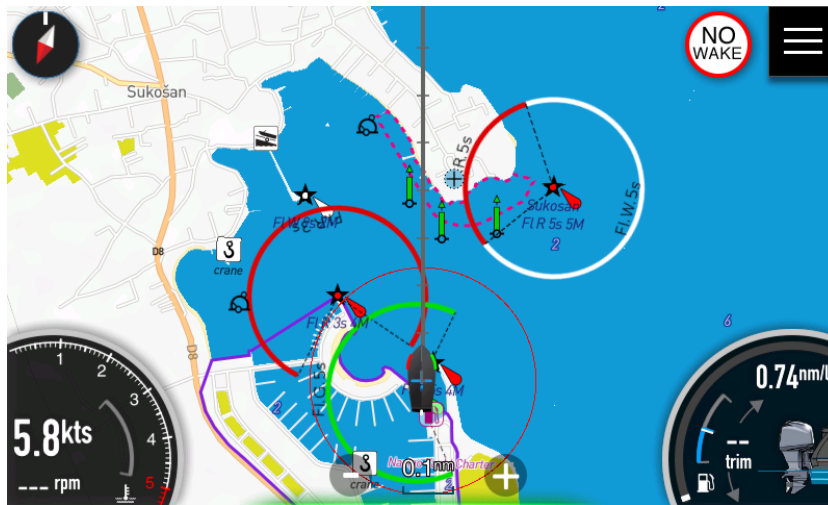

In the **Audio screen** you can control and customize the audio system on your vessel. A compatible NMEA 2000 audio system (such as FUSION marine entertainment system) must be connected to the network to enable this screen.

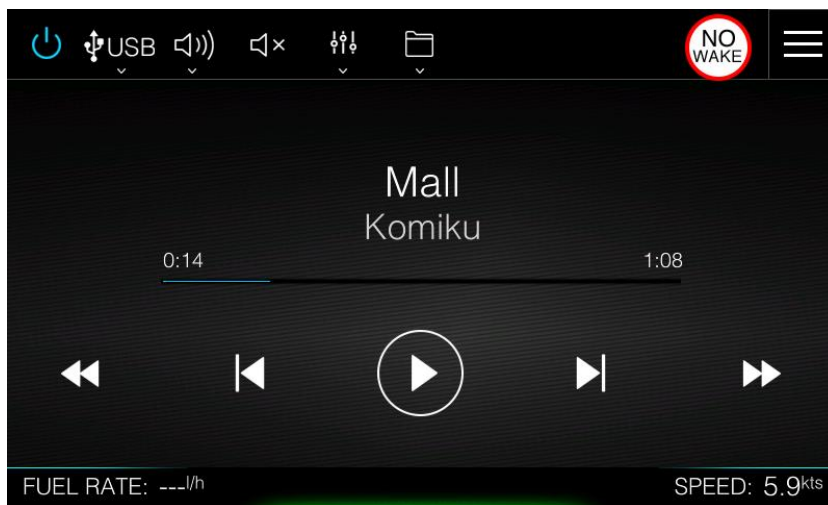

3.2 Display orientation

Device can be mounted horizontally or vertically to the panel. How to setup up screen orientation is described in Chapter 4.2.1

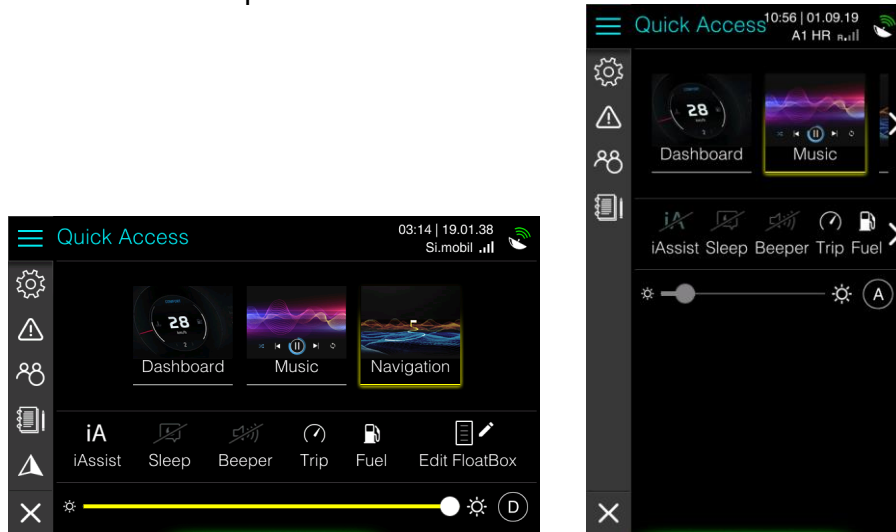

All pictures and description in this manual are for device in landscape orientation. Some minor differences in functionality might be observed, when using the device in portrait mode.

3.3 First run

When run for the first time, the device will guide you through Create profile wizard. In a profile all custom settings from user will be stored in a profile. You can modify, delete or create new profile later in the Profiles menu (See chapter 11.3)

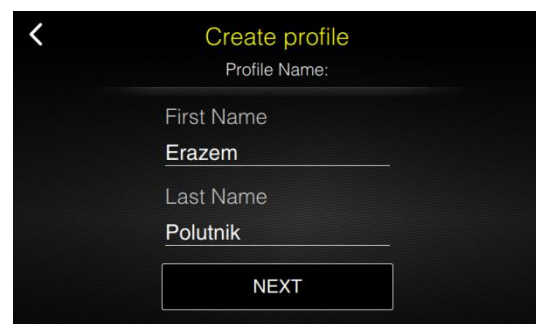
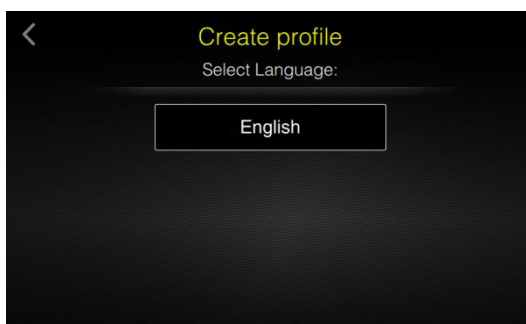



3.4 Disclaimer

At the start-up of the device a disclaimer screen will appear. It is mandatory to read this disclaimer and to confirm it in order to continue using device.

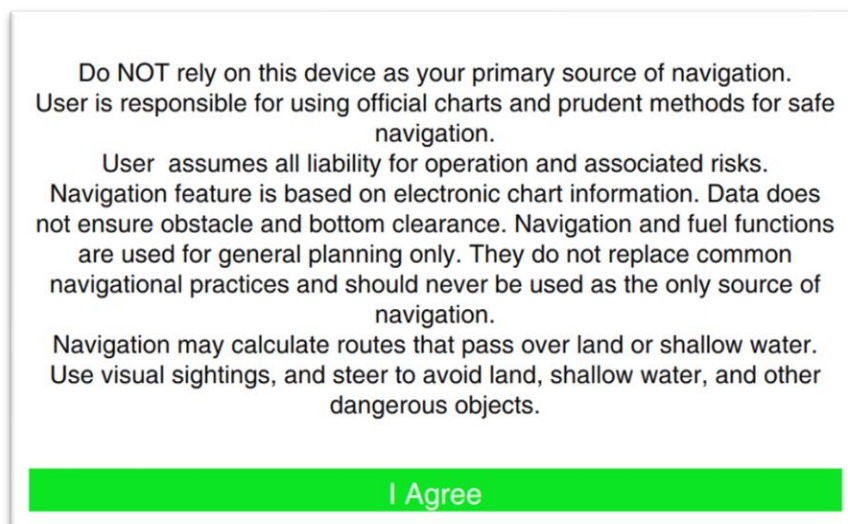

Do NOT rely on this device as your primary source of navigation or fuel estimation

The user is responsible for using official charts and prudent methods for safe navigation. User assumes all liability for operation and associated risks. Navigation feature is based on electronic chart information. Data does not ensure obstacle and bottom clearance. Navigation and fuel functions are used for general planning only. They do not replace common navigational practices and should never be used as the only source of navigation.

Navigation may calculate routes that pass over land or shallow water.
Use visual sightings, and steer to avoid land, shallow water, and other dangerous objects.

3.5 The Home screen



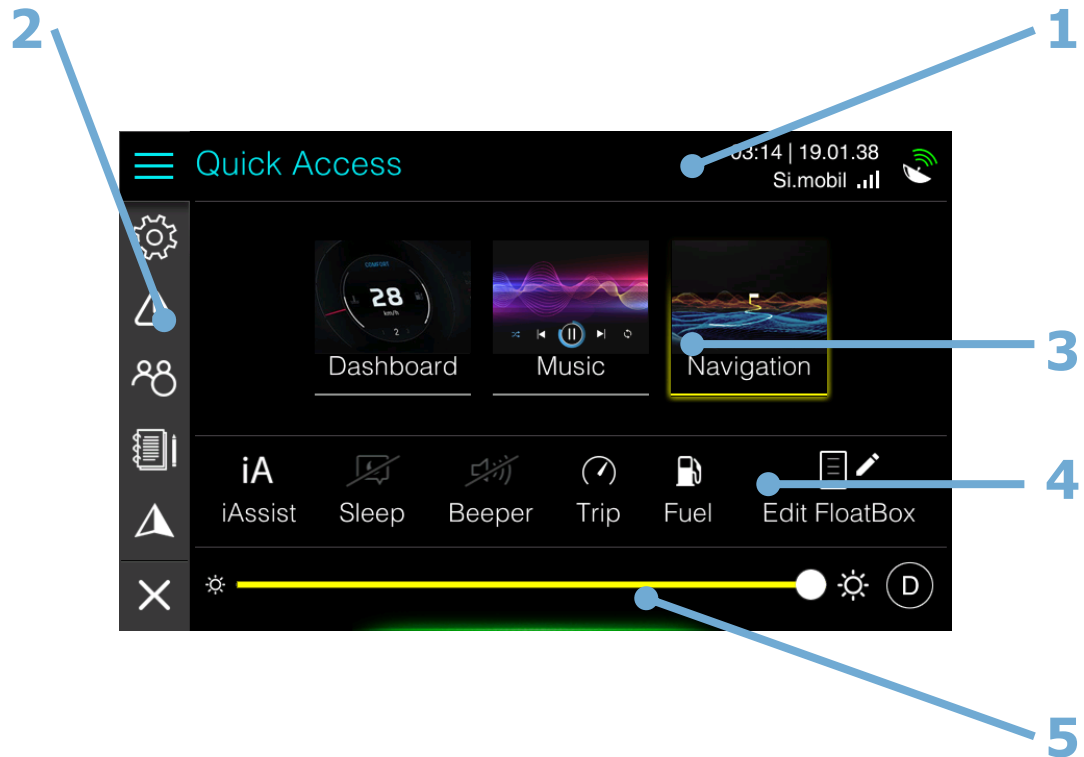



The home screen is accessed from any operation by selecting the hamburger menu icon in the top-right corner of the device screen.



- 1 Title
- 2 Main menu
- 3 Screenset selections
- 4 Shortcuts
- 5 Brightness control

The title shows, which page of home screen is currently selected. In the Quick Access page current date, time and PGS status are shown on the right side of the title. If SmartGPS is connected to the network also Operator and mobile network strength is show.

On the left side, the icons of the main menu are drawn. Press the icons on main menu to access other pages.

	Hamburger icon close home screen or brings back to quick access page
	Settings provide access to application and system settings.
	Warnings list of all current warnings and warnings history. Warning icon might turn red or yellow depend on current warning and its level.
	Profile manages user profiles.
	Logbook provides insights into previous trips.
	Navigation shows lists of favourite destinations and chart settings
	X icon returns to dashboard or map screen.

3.5.1 Quick Access page

The Quick access page provides quick access to basic system settings, which are mostly used. This page will be shown, if you press hamburger menu on dashboard or map screen or on any other home screen page.

The Quick Access page is divided into three panels.

Screenset selection panel

Screenset selection panel is used to select active screenset. On E700 more screensets can be created. A screenset is a set of selected screens. E700 is delivered with three predefined screensets named **Dashboard**, **Music** and **Navigation**.

Dashboard screenset is made of all dashboard screens available. Music screenset has only Music player screen and Navigation screenset has chart screen only.

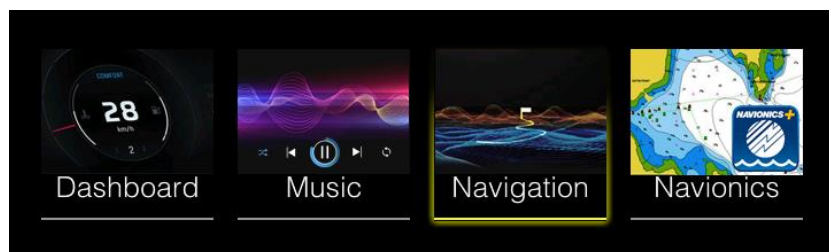

If Navionics SD card is inserted into device a fourth screenset named Navionics is available. This screenset includes Navionics chart only.

When not all defined screenset can accommodate on the panel arrows will be drawn indicating there are more screensets available. For more details how to create new screenset see chapter 11.2.

Shortcuts

Select the icon of the function you want to set or toggle on or off. For those functions that toggle on and off, a highlighted icon indicates the function is activated and grey-out icon indicates that the function is disabled.

Some icons will open a new dialog or screen.

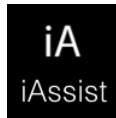

IAssist

Toggles the IAssist function for currently selected screenset on and off. To learn more about IAssist visit chapter 4.3

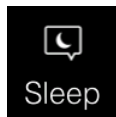

Sleep

Press this icon to enable or disable sleep mode for your device. When sleep mode is enabled, device will enter sleep mode, if it is not in use. In sleep mode screen brightness processor clock are reduced in order to save energy. It may be useful to enable sleep mode, when engine is not running and device is running on batteries only.

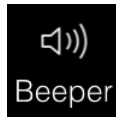

Beeper

Internal beeper acoustically warns you about alarms. This shortcut toggles beeper on and off. If you want to setup loudness level for beeper and other parameters see chapter 4.2.4

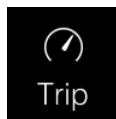

Trip

Trip will open new screen, where information about user trip are visible. Chapter 8 explains more about trips and information shown there.

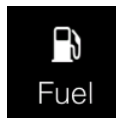

Fuel

Fuel icon is used, when you are refuelling your vessel or when you just want to change a quantity of fuel on board. Press this icon to open fuel dialog.

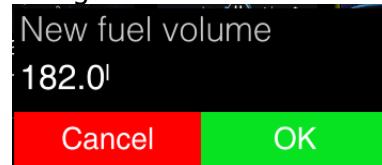

Dialog with full fuel quantity will be shown. If you want to change fuel quantity press on fuel volume and a spin control to enter fuel quantity will open.

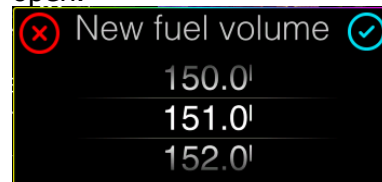

Swipe finger up and down to select proper fuel quantity. To learn more about fuel management, please look at the chapter 4.7.

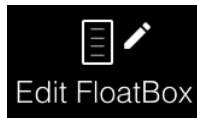

Edit FloatBox

You can add as many numerical values to any screen of screenset as you want. Select this icon to enter floating box edit mode. Edit mode will open in last screen, before you entered the Home Screen.

Chapter 11.1 Floating boxes explains into details how to edit floating boxes on the selected screen

Brightness control

The display backlighting can be adjusted at any time from this panel. Brightness can work in three different modes, automatic mode, day mode and night mode.



Automatic mode is labelled with a letter A on the right side of the panel. Slider is coloured grey and user cannot move it. Position of the slider is indicating current brightness, which is calculated with ambient light sensor. In automatic mode device will automatically switch to night mode when needed. In this case sun icon will change to moon icon.

Short press A icon to change mode to manual day mode.



When device is in manual day mode, letter D is shown on right side and user can move slider. Move slider to increase or decrease display brightness.

Long press D icon to enter manual night mode. When in Night mode letter N is displayed on right side of the panel. Sun icon is replaced with moon icon.



Move slider to increase or decrease night mode brightness. When in Night mode, screens colour scheme can turn to red colour only. This is controlled with settings in Display menu.

Short press on N icon to revert back to automatic mode.



If night mode brightness is set to low, screen might completely invisible during day. Press blindly to right bottom corner to go back to automatic mode or switch off device and switch it on again.

3.5.2 Settings

Settings page provide access to application and system settings. More detailed explanation of selected setting is described further in manual.

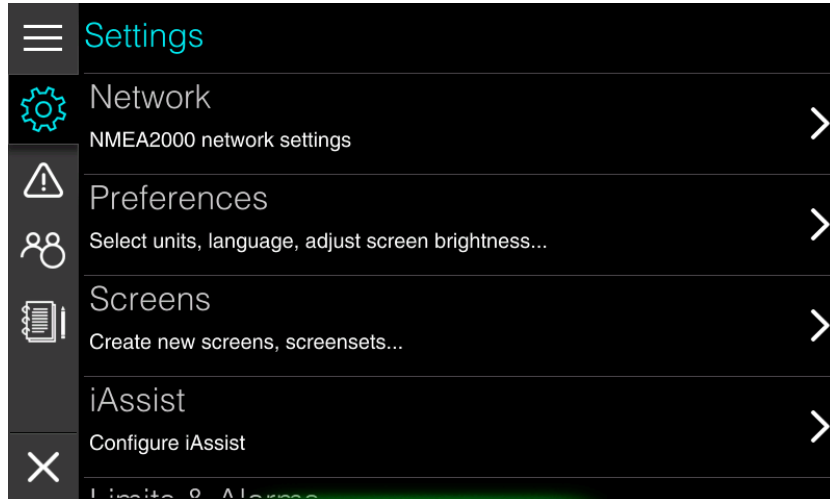

Settings are grouped into following items:

Network shows devices connected to NMEA2000 network and allow you to set sources for engine, GPS, tanks etc.

Preferences menu is used to setup device operator personal preferences regarding display brightness, time & date formats, units, beeper volume and language. It is also possible to reset everything to the default preferences.

Screens menu manages screens and screenset. It is possible to modify, create or delete new screen or screenset here. Chapter 11.2 Screens and Screensets will explain all the details.

iAssist is very powerful function of LXNAV Ex00 series device. This menu is used to enable/disable iAssist and to set parameters for it. To learn more about iAssist see chapter 4.3.

Limits & Alarms defines limits, when particular alarm is triggered for depth, fuel, speed, no wake zone or engine. Detailed explanation of Limits and alarms is given in chapter 4.4.

Maps menu shows all the information about installed maps. You can update or delete map in this menu.

Vessel parameters define basic shape parameters of your vessel. This data is further used for route calculation. It is essential that you set these parameters properly before first usage.

Connectivity menu gives user possibility to connect to the Wi-Fi hotspot and you can also update firmware in this menu. Details are given Chapter 10.

Password is used to access menus, which are hidden for normal usage. Passwords shall be used with special care and meant for advanced users only.

Owner mode is dedicated to boat owners. This menu is pin protected and designed for boat owners that are renting they boats. Here you can see owner statistic of boat usage and you can easily save and restore complete device to stored settings.

About gives information about device current software and hardware versions. Whenever you are contacting us for troubleshooting it is recommended to supply us with software version number and hardware number.



Navigating through settings

Touch menu item to navigate to next level of menu. Menu level is indicated in title panel. You can go back one level by pressing back arrow, which is on the right side of the title panel or simply touch the level in title you would like to move to.

On picture above you can notice that settings icon is having additional house symbol. Press settings icon to return straight to root level.



Once you leave main menu to chart screen or dashboard screen, main menu will stay at the same level as it was next time you come back

3.5.3 Warnings

The device continuously checks for dangerous situations and system warnings while the device is running. When a warning situation occurs, a warning message pops up on the screen. The warning is also recorded in the warning listing so that you can see the details also once you have quit warning message.

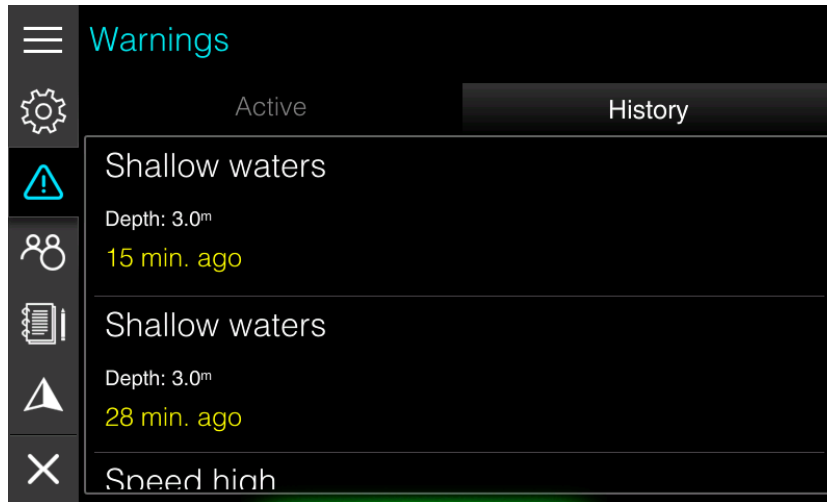

Two lists are available. Active warnings list shows all active warnings and history warning list shows all previous warnings.

Warning icon in main menu will be colour coded based on active warnings, red for critical warnings and orange for important warnings.

How to setup and more details about warning manipulation you can read in chapter 4.4 Warnings.

List of active warnings and list of history warnings can be seen in Home screen>Warnings page.

If more than one warning is triggered at the same time, the one with higher priority will be displayed first. However, all the warnings will be pushed to the list of active warnings and later to the history list

Parameters and limits for warnings are defined in Home screen>Settings->Limits & Alarms. More detailed explanation of Limits & Alarms is given in next chapter.

Limits & Alarms

3.5.4 Profiles

The device can have several profiles. In a profile user preferences and customized screens and screensets are stored. Profiles can be used, when more than one person is operating device and each individual person, would like to have his own personal look and feel of the device.

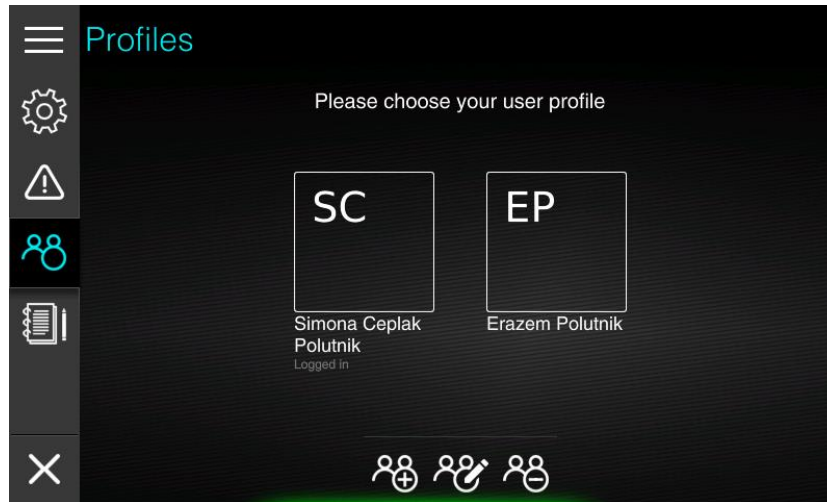

This menu is used to add, delete or edit profile. More information about Profiles are explained in chapter 11.3 Profiles.

3.5.5 Logbook

Logbook stores and recalls information about your previous trips. You can view more detailed statistic of your previous trip or delete a trip.

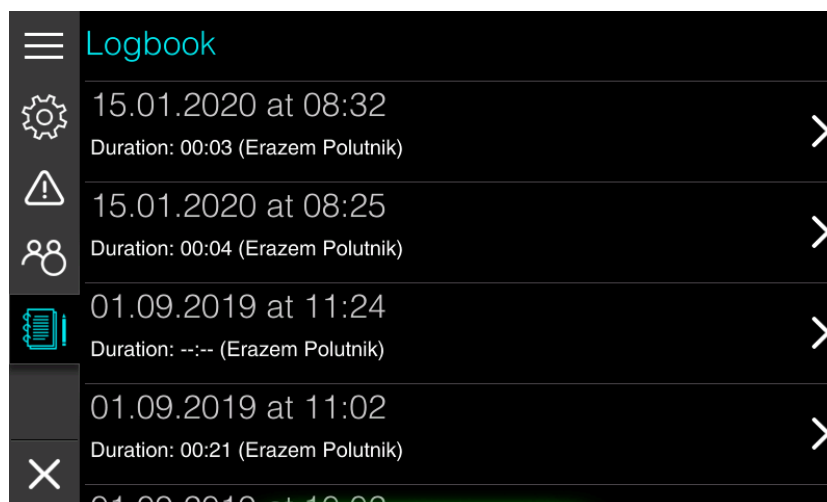

More details about trip statistics is given in chapter 8 Trip.

3.5.6 Navigation

Chart settings and list of favourite destinations are shown under this menu. A menu item is visible only, if you have entered the Home screen from chart screen

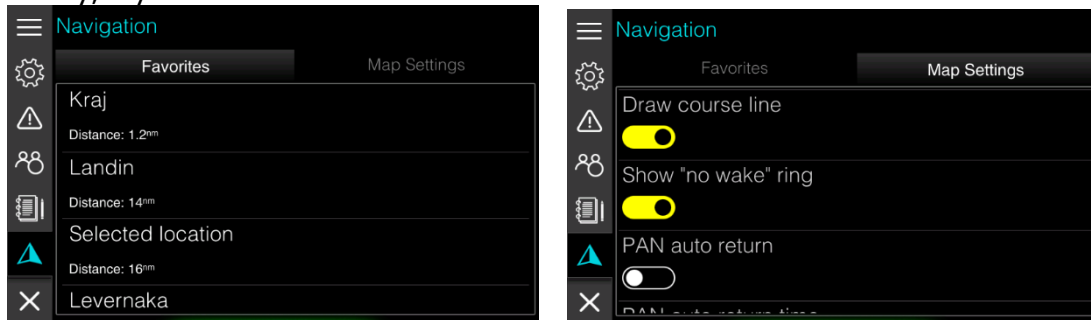

See chapter 6 Charts and 7 Navigating for detailed description of chart settings and manipulation for favourite destinations.

4 Basic operation

4.1 User interface

The Ex00 device is multi-touch device and operation is very similar to operation of modern smartphones. You can tap to select a menu and a dialog item or start editing, toggle a checkbox option on or off. Press and hold to get chart item information.

Scroll through a list of available options without activating any option or flick to scroll quickly through lists.

Pan to move the chart to selected location. Pinch to zoom out on the chart or spread to zoom in.

4.1.1 Keyboard input

When keyboard input is needed a keyboard is displayed. Left above text input red X icon is displayed and right above the input blue checkmark is displayed.

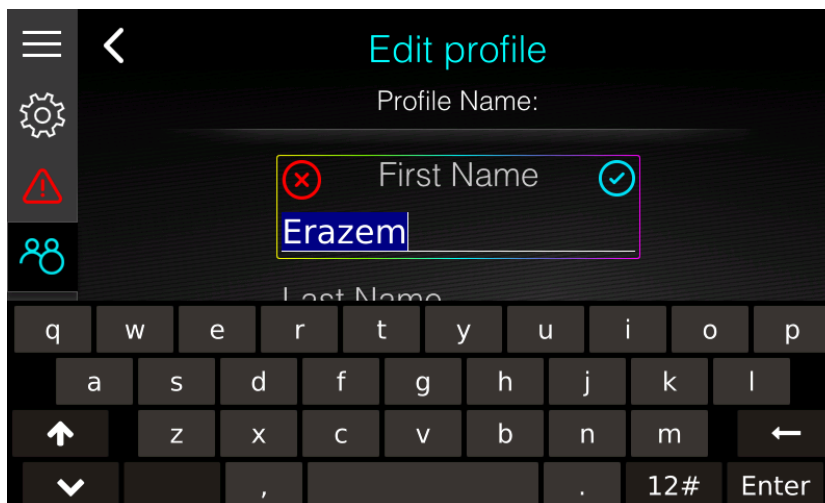

Once you have finished entering text, press red X icon to cancel editing and exit without saving changes. Press ENTER button on keyboard or blue checkmark to confirm changes and exit editing mode. Press UP arrow to switch to upper case letters. If you would like to do CAPS LOCK double, click UP arrow.

4.1.2 Spin controls

Spin controls are used when you have to enter numerical parameter



Scroll through list of values or flick to scroll quickly through lists. Touch the value to stop scrolling. Press blue checkmark to confirm changes and exit editing mode or red X icon to cancel editing, without saving changes.

4.1.3 Sliders

Sliders are also used to enter numerical parameter, when exact value of parameter is not needed. It is used for brightness input or level of details input.



Touch the white marker and slide it to one side to make changes.

4.1.4 Checkbox

Check box is used, when you have to enable or disable an option. When option is disabled a checkbox is drawn as on picture below.



When option is enabled, checkbox is draw as following.



Slide white marker to one or other side to make changes or just tap checkbox to toggle on or off.

4.1.5 Gesture mode

The E-series devices can also be manipulated using gestures. Gesture mode must be first enabled in Display settings. Once gesture mode is enabled you can slide screen waving with your hand in front of display without touching it. This is very useful, when your hands are wet or dirty.

Following gestures are available: swipe left or right is same as turning jogwheel left or right. Swipe up is same as pressing jogwheel once. Swipe down is same as pressing jogwheel twice.

4.2 Preferences

You can access Preferences menu from the Home screen through settings page. This menu is used to setup personal preferences regarding display brightness, time & date formats, units, beeper volume and language. It is also possible to reset to default preferences.

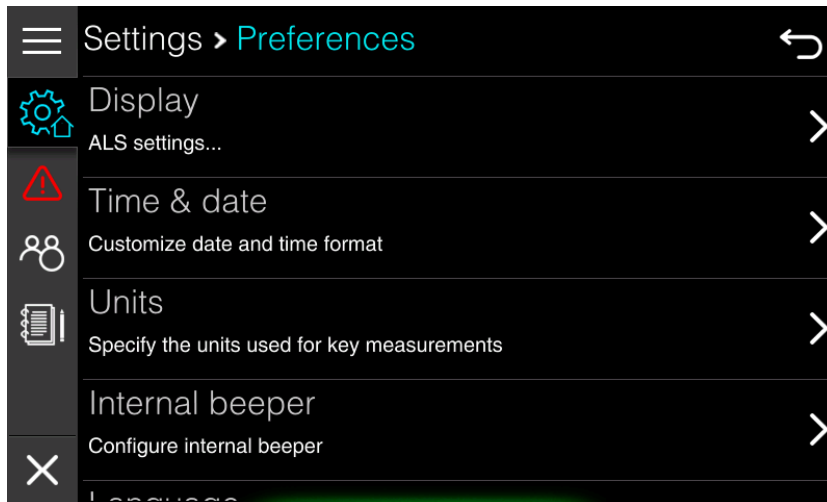

4.2.1 Display

Display orientation and brightness are set up in this menu. It is also possible to enable gesture mode.

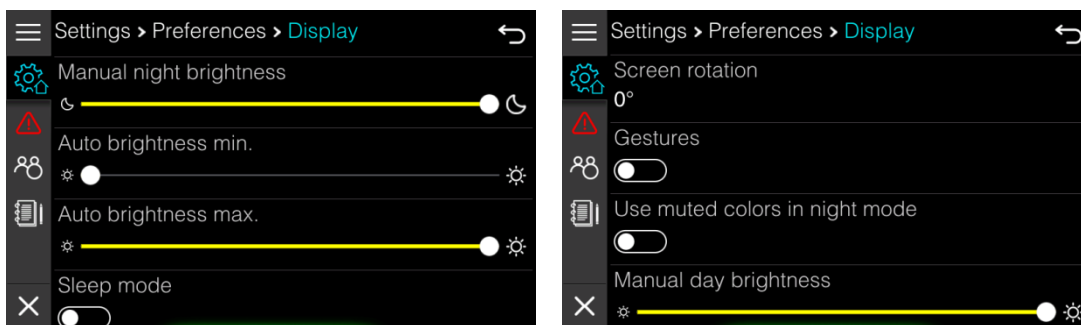

Move sliders to set up appropriate brightness control. When slider is moved, brightness is changed to level of slider position.



When changing screen orientation floating boxes positions might alter. It is recommended to set screen orientation first and then do the customization of screens.

Use muted colours in night mode, will turn the entire screen to reddish colours when in night mode as seen on picture below.

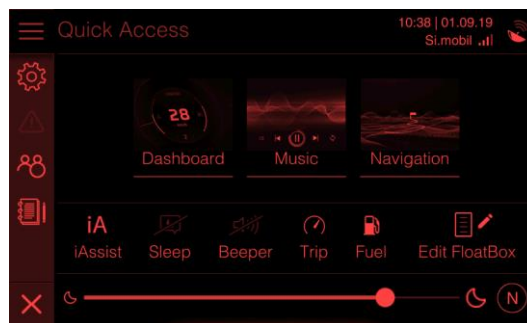

Gesture mode was described in chapter 4.1.5.

4.2.2 Time & Date

Time and date format can be set here. Time and date are acquired through GPS signal therefore an active GPS antenna is required. You can also setup UTC offset here, which is used when local time is displayed.

4.2.3 Units

During first run you have selected, if your device will operate in metric, imperial or US system of measure. In this menu you can define units for all measurements separately.

4.2.4 Internal beeper

In this menu loudness of internal beeper is set. Move slider to change loudness of internal beeper. An audio tone will be played to hear loudness as well. Internal beeper can be enabled or disabled.

Beeper can also be enabled or disabled from the Quick Access page directly.

4.2.5 Language

Select the language of the user interface. If your language is not supported and you would like to contribute to translations, feel free to contact us.

After the language is changed the device restarts automatically.

4.2.6 Reset Profile

Reset profile option will reset all the profile setting to default. A confirmation dialog will be shown to confirm reset. Use with caution as you cannot revert the process.

4.3 IAssist

IAssist is very unique and powerful feature of LXNAV E-series devices. IAssist is a screen assistant that automatically switches between screens based on complex logic and definable parameters. On a picture below IAssist screen for engine trim is shown. It will pop-up automatically, when user start trimming the engine.

Such assistance is also available for speed, depth, rudder and fuel efficiency.

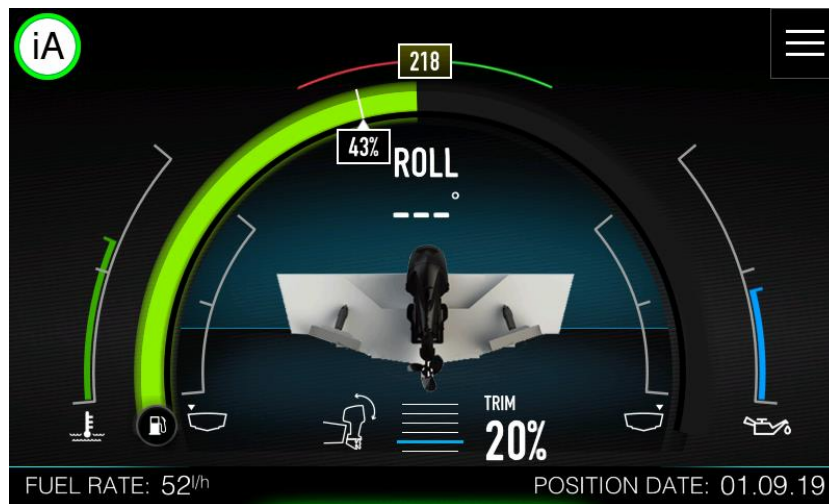

Next two pictures are showing IAssist screens for speed and for shallow waters. IAssist screen will be displayed, when you are too fast and too close to the coast. IAssist screen for shallow water will be shown, when you are approaching shallow waters.

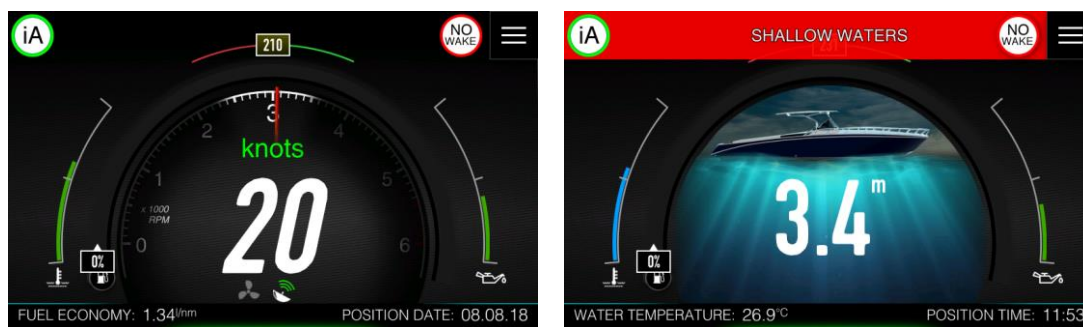

When IAssist screen is displayed, green icon with iA label will be drawn in top left corner of the screen. Press it to dismiss IAssist screen.

4.3.1 Setup IAssist

IAssist can be setup up in Settings>IAssist menu. There are two sub menus available: Screen assistant menu and Speed source transition menu.

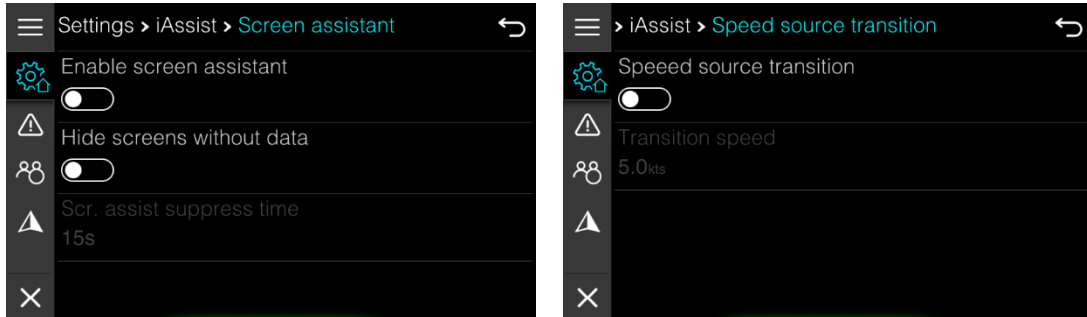

More detailed parameters can be setup under Settings>Password menu. To find out, which password is needed to setup more IAssist parameters see Chapter 11.5.

Screen assistant menu

To enable or disable IAssist use screen assistant checkbox. IAssist can also be switched on or off in the Quick Access page. It will be switched off for the currently selected profile. Screens without any data will not be shown, if **hide screens with no data** is turned on. Suppress time means how long the IAssist will be ignored and will not bother you.

Speed source transition

Ex00 device will automatically switch from a GPS to Paddle speed (if transducer is connected) at defined transition speed. You can define speed threshold in this menu.



At a low speed Paddle speed is more accurate, while at high speed is the GPS speed.

4.4 Warnings

The device continuously checks for dangerous situations and system warnings while the device is running. Some of the warnings are also received via NMEA200 network from other items connected to network such as engine, battery monitors etc. When a warning situation occurs, a warning message pops up on the screen.

If you have enabled the beeper, the warning message is followed by an audible alarm.

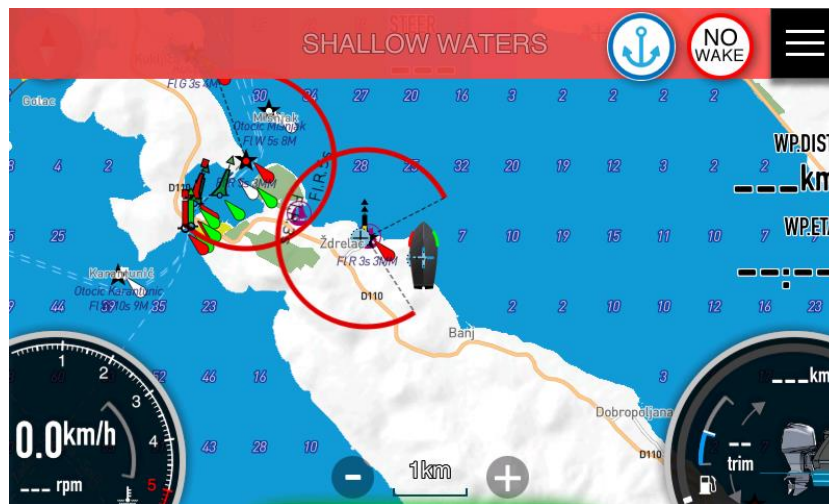

The warning is also recorded in the warning listing so that you can see the details and take the appropriate corrective action.

4.4.1 Type of warnings

The warnings are classified according to how the reported situation affects your vessel. Warnings are also colour coded. The following levels of urgency are used:

Colour	Importance
Red	Critical
Orange	Important
White	Information

List of active warnings and list of history warnings can be seen in Home screen>Warnings page.

If more than one warning is triggered at the same time, the one with higher priority will be displayed first. However, all the warnings will be pushed to the list of active warnings and later to the history list

Parameters and limits for warnings are defined in Home screen>Settings->Limits & Alarms. More detailed explanation of Limits & Alarms is given in next chapter.

4.5 Limits & Alarms

To configure limits for alarms that are triggering warnings go to the Home screen>Settings->Limits & Alarms. Limits & alarms are divided in following groups: depth alarms, fuel alarms, speed alarms, No wake zone alarm, engine alarms and other alarms. Select an item to configure particular limit.

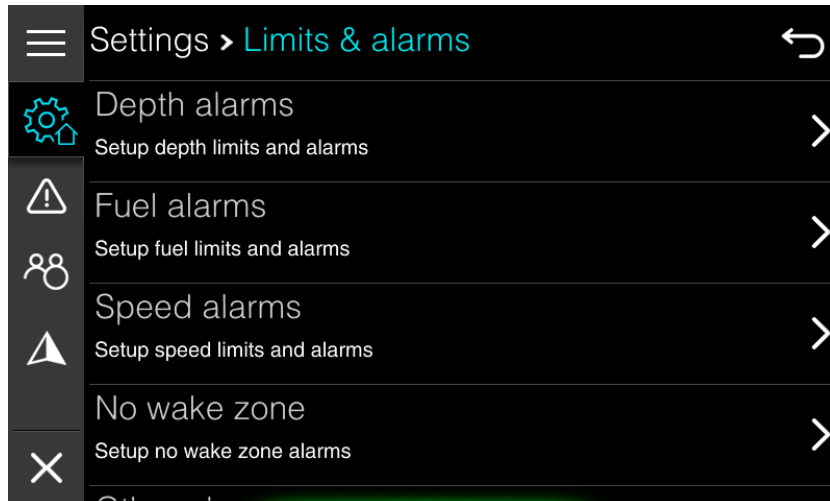

Depth alarms

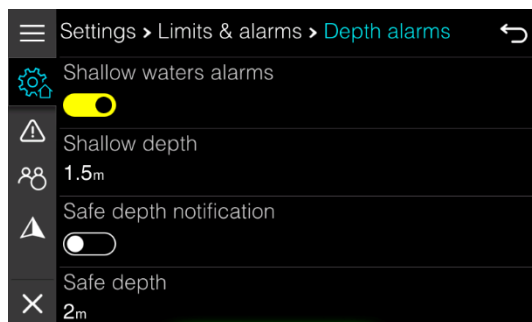

On your device you can set two different depths. First one is call safe depth and the other one is called shallow waters. This allows you to setup two stage depth warnings.

You can enable or disable them separately.

When depth is going to be lower than selected safe depth, important warning (orange) will be triggered and displayed.

When depth is going to be lower than shallow water limit, critical warning (red) will be displayed.

Fuel alarms

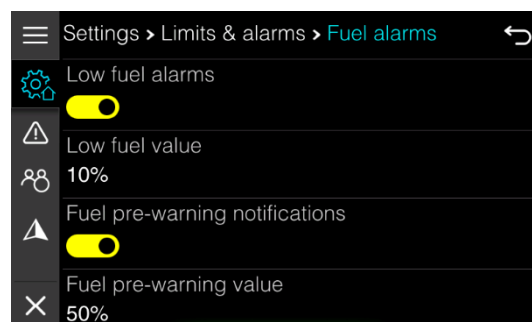

For fuel you have also two stage warning system. Fuel pre-warning value will generate informational warning (white). Low fuel value will generate important warning.

Fuel warnings are generated based on calculated fuel quantity. Fuel management is described into details in Chapter 4.7.

Speed Alarms

You can set a speed limit. When your vessel will exceed this limit a warning for high speed will be shown.

No wake zone

Your device is constantly monitoring distance from the coast. In this menu you can setup a distance which will trigger no wake zone alarm. When distance to coast is smaller than limit set here, round no wake symbol will be displayed in top right corner of your display.



If IAssist is enabled and your speed is above speed threshold for no wake zone speed dashboard screen will be displayed.

No wake distance is also taken into account, when calculating route. It is assumed that, when close to the coast, your speed is going to be reduced to 8 knots. This limit can be set under password.

Route is always optimized for time, rather than for distance.

Engine alarms

Engine alarms contain a list of all engine alarms that can be reported by engine itself via NMEA2000 network. You can enable or disable each individual warning.

By default, all warnings are enabled.



This menu is meant to be used only by experts. Some engines might report faulty errors and for such cases you can disable warnings here. If you are not sure, if this is real warning or not, please consult engine expert and leave all the warnings enabled.

Other alarms

Your device is constantly measuring supply voltage. You can set a voltage limit in this menu and when a voltage will drop below this limit for some period of time a battery warning will be shown.

This will automatically trigger a warning when you will enter safe depth.

You can also enable or disable position watch warning. More about position watch warning you can read in Chapter 4.8.

4.6 Vessel Parameters

Basic vessel parameters are set in this menu. You should enter these parameters before initial use as some of the parameters are used for route calculation.

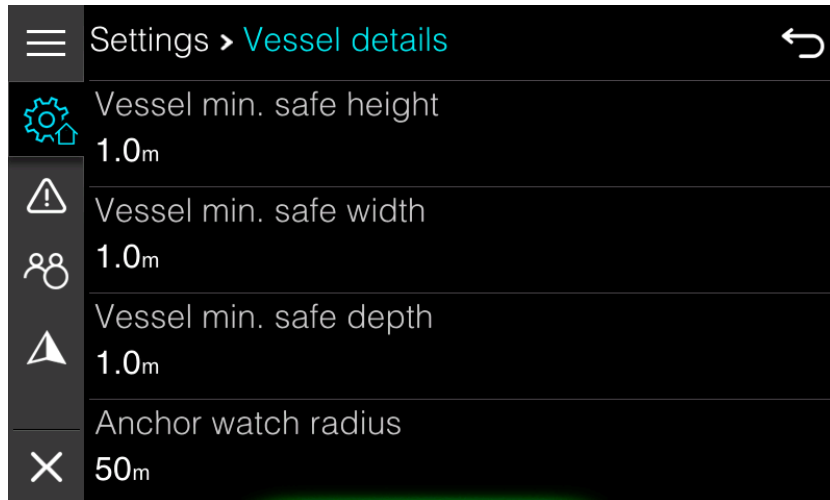

When using route function on OpenSeaMap charts, route calculator does not take into account vessel minimum safe depth and height. It is operator's responsibility to avoid shallow waters and observe height, when passing below bridges and other objects.

Anchor watch radius

Enter anchor watch radius, which is used for position watch alarm.

Cruising speed

Cruising speed is just an initial guess of your vessel cruising speed, which is used for route calculation. As mention before, use is always optimized for time rather than for distance.

Fuel tank volume

When there is no fuel level sensor installed on a boat, fuel quantity is calculated from fuel flow as reported by engine. Enter your fuel tank volume here. This volume will be used to calculate percentage of fuel left on board and it will be suggested, when refuelling your vessel.

Echo fuel data

Your device can also report fuel quantity and fuel capacity via standard NMEA2000 fluid PGN. Enable this option, if you want to use fuel quantity as reported by this device also on other devices connected to NMEA2000 network.

4.7 Fuel

Fuel quantity is one of the most important values for vessel operator. We do take a lot of care to calculate fuel on board as precise as possible, however it is always operator responsibility to have knowledge how much fuel is on board and to take proper actions regarding fuel when needed.

Device and its software cannot be responsible for situation, when vessel is running out of fuel. On Ex00 device fuel quantity is estimated using two different methods. Calculated fuel quantity, which is calculated from fuel flow as reported by engine and measured fuel quantity, which is measured with fuel level sensor, if installed.

Calculated fuel

Engine connected to NMEA2000 network will usually report current fuel flow, when engine is running. From this fuel flow and from initial fuel quantity entered by operator remaining fuel on board is calculated.

This method is having few shortcomings. Error by reported fuel flow is accumulated and may cause big discrepancy in estimation of remaining fuel.

Fuel may be leaking and this will cause loss of fuel, which can not be detected by this method. Engine was running, when device was switched off. In this case you will display a warning as shown on picture below

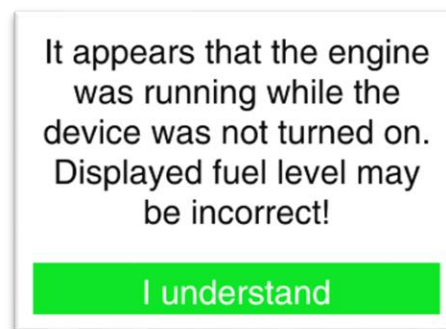

Measured fuel

When a fluid level sensor is connected to NMEA2000 network a value reported by this sensor is called measured fuel quantity.

Fuel quantity reported by fuel level sensor can be calibrated internally on device. A calibration method for fuel level sensor is described in Chapter 11.4.3.

Measured fuel quantity varies a lot because of boat movement in all axes. We take a lot of care to measure fuel as accurate as possible.

When measured fuel and calculated fuel differs too much, operator will be notified about this situation and he can correct it with a single click.

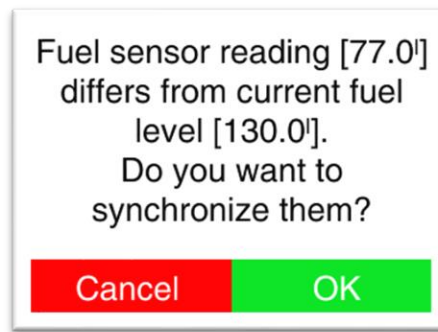

Calculated fuel and measured fuel are both shown on dashboard screens, fluid screen and chart screen. User can also set a floating box with both values.



We took a great care to calculate measure and display fuel as accurate as possible. However operator is responsible for amount of fuel on board. In case of doubts operator should visually inspect amount of fuel on board or refuel it.

4.8 Anchor watch

Once a vessel is coming to a rest an anchor icon will be displayed in top right corner of device display. Press it and device will enter anchor watch mode. Icon will change. Number in upper right corner indicates distance from anchor position.



When distance from anchored position is going to be greater than the one defined in the Home Screen>Settings>Vessel Parameters, anchor watch warning will trigger. Icon will change color and audible alarm will start, if enabled.

Anchor watch can be enabled on all screens except the Home Screen. When anchor watch is switched on a chart screen, chart will be zoomed in. Anchor watch area will be drawn around boat and rest of chart will be dimmed.

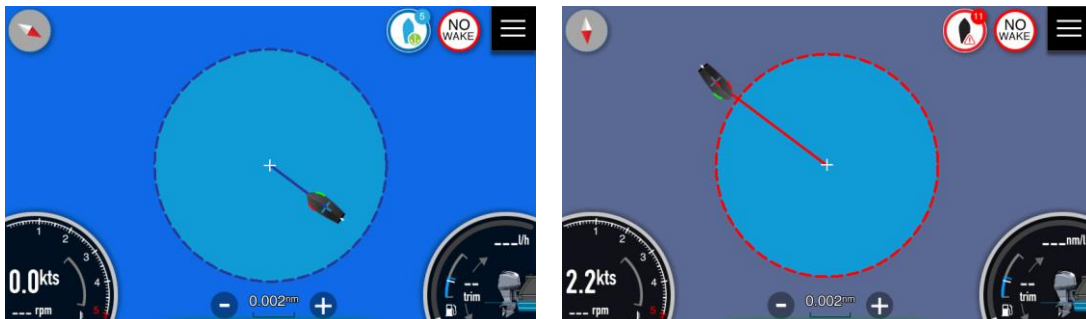

If compass is presented on NMEA2000 network, orientation of vessel is based on compass heading, otherwise vessel is always pointing towards anchor position.

5 Dashboards

The dashboard screens consist of various gauges which can be analogue, digital or bar gauges. Gauges can be customized to display selected data. Multiple dashboard screens can be added to a screenset. To learn more about screen and screen set customization see chapter 11.2. Default dashboard screens are described in this manual.



To include fuel data or engine information, engine and tank data source must be defined,

A set of dashboard screens are predefined in dashboard screenset. You switch between the dashboard by swiping the screen left to right or right to left. If gestures are enabled, you can just move your hand in front of screen left to right to toggle dashboards. Turn jogwheel left or right to select next or previous dashboard screen.

When IAssist is enabled, it will automatically be switched to corresponding dashboard screen for a given situation. In this case an iA icon will be shown in top-left screen.



You can quit IAssist screen by pressing iA icon or by pressing jogwheel.

5.1 Fuel economy



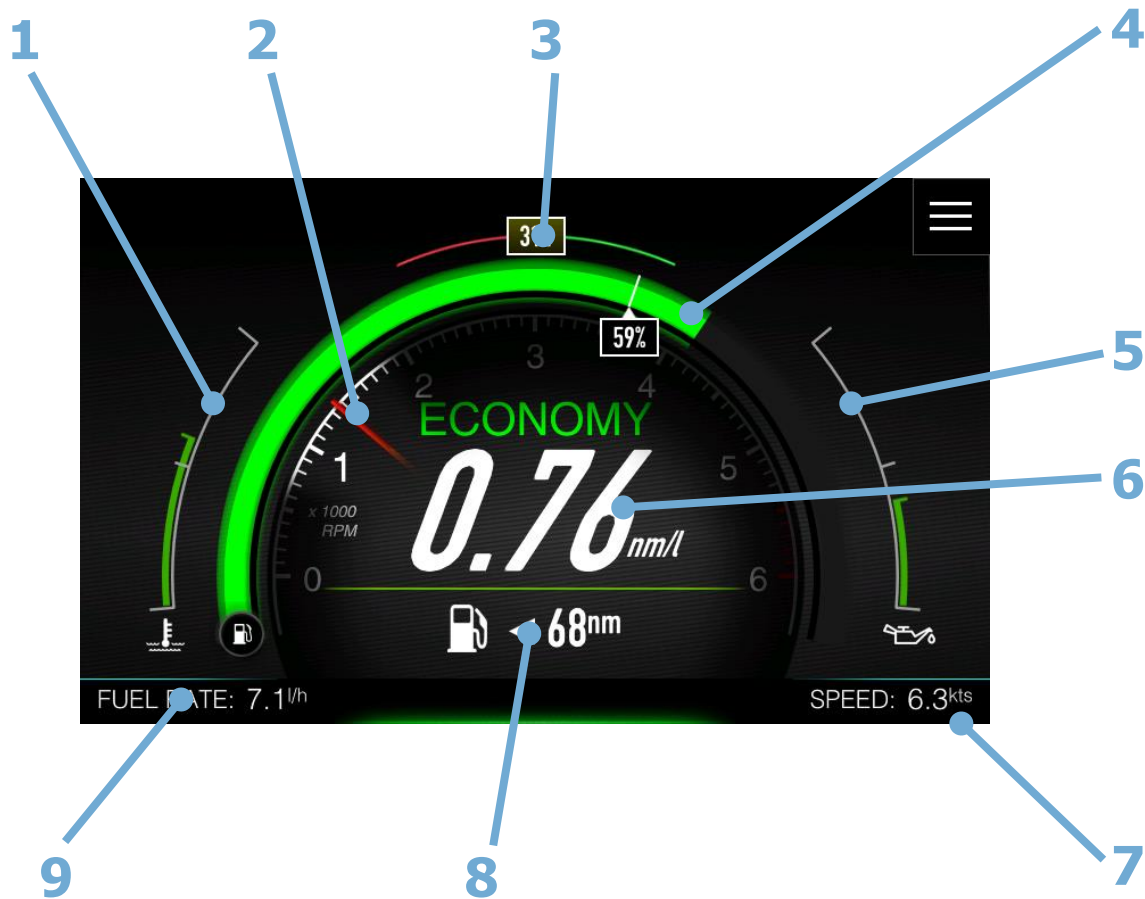





Primary functionality of this dashboard screen is to show operator the fuel economy in selected units.



- 1 Left gauge *
- 2 Inner gauge – RPM indication
- 3 Compass heading or ground course *
- 4 Center gauge – Fuel *
- 5 Right gauge *
- 6 Current fuel economy
- 7 Bottom right value – Speed over ground *
- 8 Additional trip/fuel information
- 9 Bottom left value – Fuel rate *

* This gauge is available on all dashboard screens

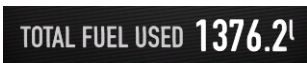
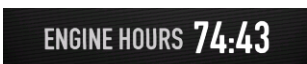
You can select addition trip and fuel information, if you put your finger on number and swipe up or down. Following options are available:

	Estimated range based on current fuel consumption and remaining fuel estimation.
	Estimated engine running time based on current fuel consumption and remaining fuel estimation.
	Remaining fuel estimation.
	Average trip fuel economy
	Current trip distance
	Fuel used for current trip
	Total fuel used since device was installed
	Engine hours as reported by engine
	Reset trip statistic.

It is also possible to change information using jogwheel, when installed. Press jogwheel for short time. The focus will change as seen on next picture.



Scroll jogwheel to toggle between values. Press it once more to release focus. Screen can be customised in Screen settings. See chapter 11.2.2.

5.1.1 Centre gauge –fuel or battery state of charge

By default a green arc is showing remaining fuel quantity. It consists of two parts green arc and white pointer.



When a fluid level sensor is connected to network, green arc will display averaged measured quantity and white pointer will show calculated fuel.

If only calculated fuel is available, white pointer will always be at the end of arc.

White pointer is not drawn, if only measured fuel is available.

Colour or arc will change from green to yellow, when quantity is below pre-low fuel quantity and to red, when is below low fuel limit. Fuel limits are set in Limits & Alarms.

Other options for centre gauge can be defined in Screen edit dialog. It is possible to select between fuel level, oil level or SOC of electric drivetrain battery.

The last option is particularly useful for vessels with electric power train.

5.1.2 Inner gauge – RPM indication

By default the inner gauge will show RPM indications.

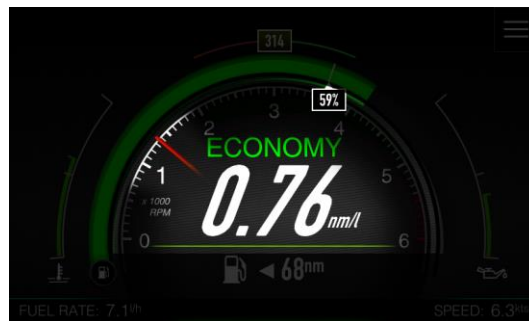

The other option is electric drivetrain power. This is particular useful for vessels with electric power train.

5.1.3 Left and right gauge

Left gauge will show engine temperature and right gauge will show oil temperature by default. Indication is colour coded and will change colour from green to red, based on colours as defined by engine calibration (Chapter 11.4.3)

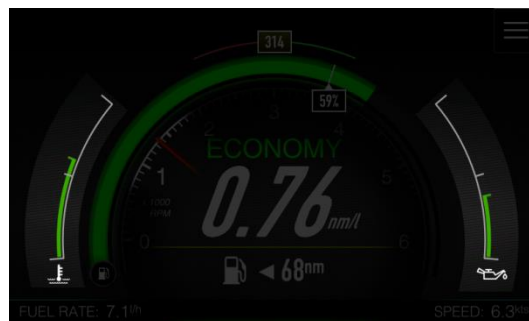

Following options are available for left or right gauge: fuel pressure, fuel level, oil level, electric drivetrain battery, electric drivetrain power, oil pressure, oil temperature, coolant pressure, engine temperature, engine trim, port trim tab and starboard trim tab.

5.2 Speed

The speed screen shows the current ground speed or water referenced speed. Indication what speed is used is drawn with a symbol on the bottom of the page. Propeller indicates water

speed, measured with paddle wheel or depth sensor is displayed and satellite symbol indicates GPS derived speed is used.

The system will automatically switch from vessel speed to GPS speed at a user defined value, which can be set in IAssist setup.



Rest of the parameters is similar to Fuel economy screen and can be further customized in Screen menu.

5.3 Compass

If compass is connected to the NMEA2000 network, screen shows compass rose and compass heading, additional with current position.

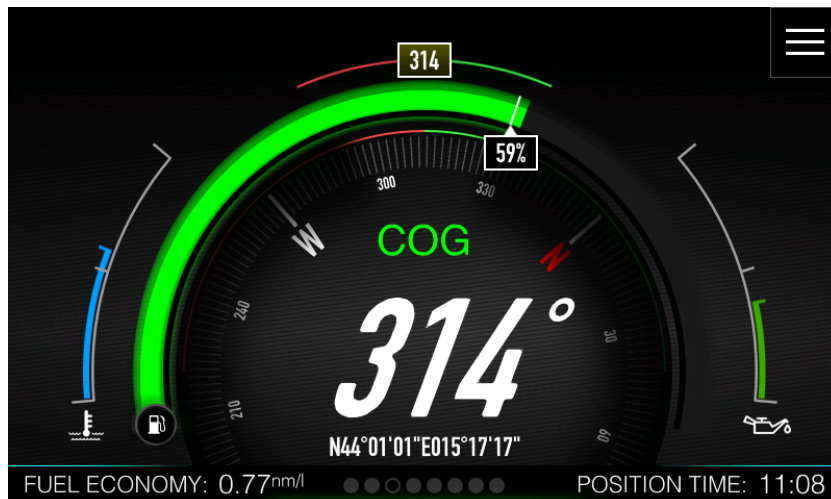

When compass is unavailable, course over ground is displayed and text label is changed to COG. All other parameters are similar to previous pages.

5.4 Trim

This screen is dedicated to engine trim position and tabs position. When SmartGPS or similar device is connected to the NMEA2000 network, vessel roll angle is shown on above the picture of vessel.

Data for the Trim angle is acquired from the engine via the NMEA2000 network and will only be displayed if data is available.

Port and starboard trim tab position is shown, when trim tabs are connected to the NMEA2000 network.

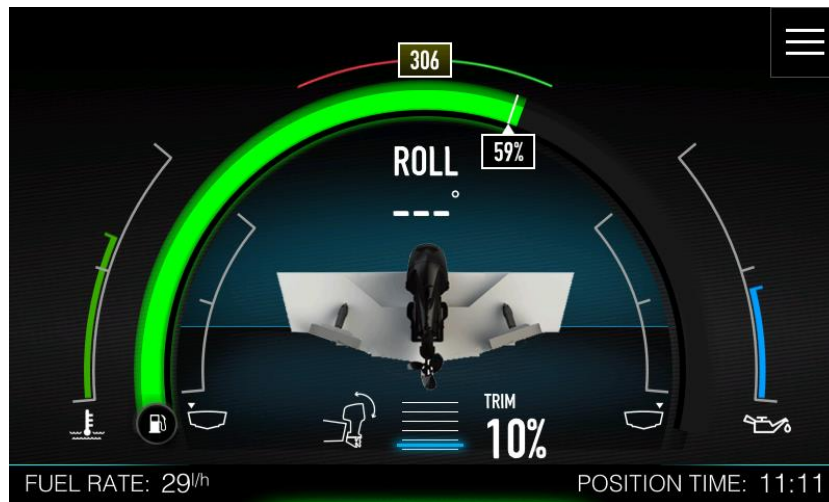

5.5 Rudder

Rudder position is displayed on on this screen together with numerical value of rudder position. If IAssist is enabled this screen will be shown, when in harbour and ready to move your vessel.

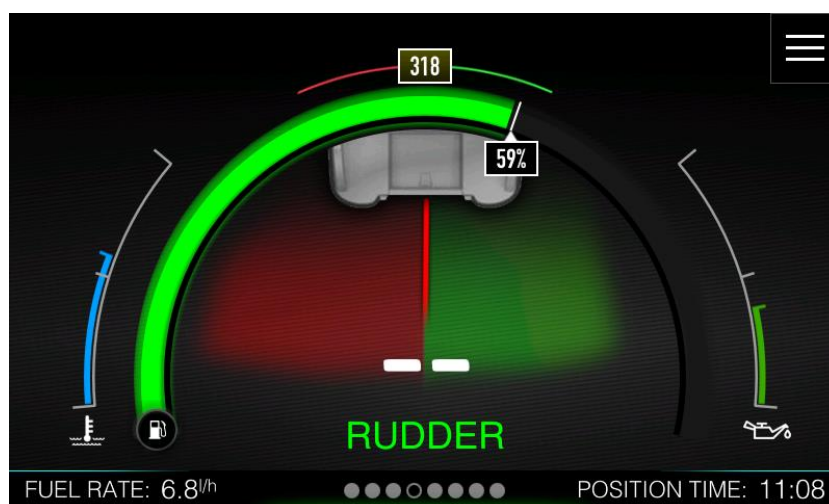

5.6 Depth

The screen shows a numeric depth and visual indication for deep/shallow waters. Water with sea bottom below the picture of vessel is coloured red, when in shallow waters. Deep water is having blue water without the sea bottom.



5.7 Fluids

Fluids screen displays quantity of fluid level for fuel, oil, fresh water and black water. For easier presentation each fluid is colour coded. Each tank is also showing numerical value of current fluid level and total tank capacity. Level of fluid is not even, as you can see not the picture below, some spikes are visible on fresh water tank.

Level actually presents a time series of measurements as reported by fluid level sensor. A numerical value below is averaged fluid level.

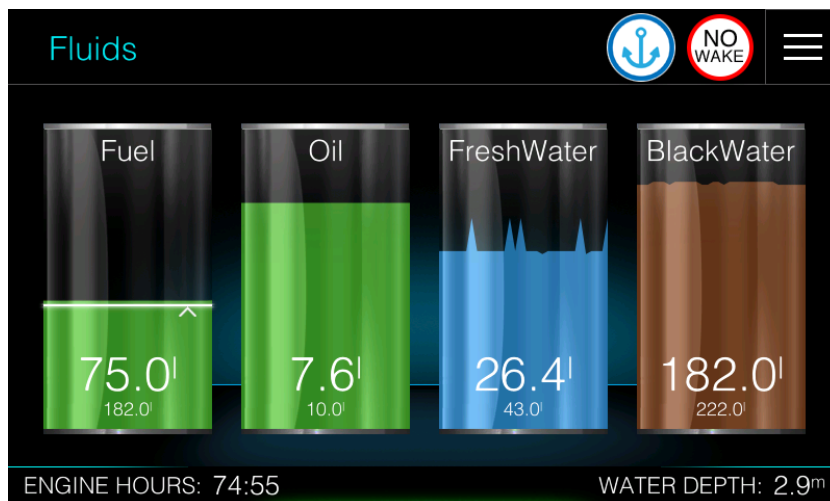

Fuel tank is a bit special. When measured fuel and calculated fuel data are available, measured data is presented as any other fluid level, with a times series graph as a level. Calculated data is drawn with a white line and a pointer on the right side.

When only calculated data is available, white line is always drawn at the top of green bar.

When only measured data is available white line is not shown.

5.8 Battery

Battery screen display state of charge for a selected battery. Numerical value is shown on the bottom of battery symbol and expected remaining time at current consumption is presented below it. Device can display this information for up to two batteries.



Battery information is available only if a SmartSHUNT or similar device is connected to the NMEA2000 network. SmartSHUNT is battery monitoring device, which constantly measures current, voltage and temperature of a battery and calculates state of charge and state of health of the battery.

Up to two such devices can be selected in the network settings.

6 Charts

The chart function displays your boat position relative to land and other chart objects. On the chart panel you can plan and navigate to selected destination or you can mark your favourite spots.

6.1 The Chart Screen



- 1 Chart orientation symbol
- 2 No wake symbol and anchor symbol (1)
- 3 Home screen symbol
- 4 Fuel economy gauge (1)
- 5 Chart scale symbol and zoom controls
- 6 Vessel symbol
- 7 Course extension line (1)
- 8 RPM gauge (1)
- 9 Route (1)
- 10 Floating boxes (1)

(1) There gauges can be enabled of disabled by user.



Vessel symbol

When the system has a valid GPS position, the vessel symbol indicates vessel position. Cross inside of vessel shows exact position. If no GPS position is available, the vessel symbol includes a question mark.

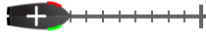

Course extension line

Line is drawn in direction vessel is moving (COG). Each small dash indicates distance that will be travelled in one minute. Large dash shows 10-minutes distance. At larger zoom only 10-minutes dashes are visible.



Chart scale and zoom controls

You zoom in and out on the chart by using the zoom panel icons, or by using fingers to pinch (zoom out) or spread (zoom in).

Chart range scale is shown in the lower part of the chart, between zoom controls.

Chart orientation

Two options are available for how the chart is rotated. The chart orientation symbol in the top left corner indicates the north direction and shows which option is currently in use.

Touch it to toggle between orientation possibilities



North up displays the chart with north upward. **Heading/Course up** displays the chart with the vessel's heading directed upward. If heading is not available, then the COG from the GPS is used. Red part of needle is pointing towards north.



Pan mode indicates that chart is in PAN mode. Orientation symbol will change colour to grey and once in pan mode, orientation will not change anymore.

No wake symbol



It will pop-up, when you are close to the coast. It warns you to take care of vessel speed.

Anchor symbol



It appears when vessel is stationary and ready to anchor. To learn more about anchor mode see Chapter 4.7.



RPM gauge

RPM gauge shows essential information about your engine. It features RPM scale with needle.

Top number shows your current ground speed

Bottom number shows current RPMs

Inner gauge indicates engine temperature and is color coded based on temperature.

Fuel economy gauge

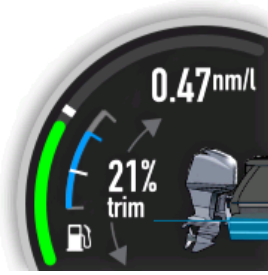

Fuel economy gauge is used to optimise your fuel efficiency. The fuel economy gauge displays the instantaneous versus historical average fuel efficiency. Green bar shows instantaneous fuel efficiency and white dash represents three minutes averaged fuel efficiency.

Inner gauge displays fuel tank. Blue bar is calculated value of fuel on board and white dash is last measured fuel quantity.

On top a numerical value of fuel efficiency, fuel consumptions and estimated fuel range will cycle every few seconds.

Middle number is indication of current trim. When engine is moving up and down, correspondent arrow will turn to green colour.

WP.DIST.
12nm
WP.ETA
12:15

Floating boxes

It is possible to add numerical data to any screen. Numerical data are organized in floating boxes. To learn more about adding/deleting and customizing of floating boxes see Chapter 11.1

6.1.1 Panning the chart

You can move the chart in any direction by dragging your finger on the screen. Press Orientation symbol to restore chart position and orientation back to previous state.

6.1.2 Displaying information about chart items

Long press on a chart to show information about selected chart item. Dialog with a list of all items near pressed location will pop-up.

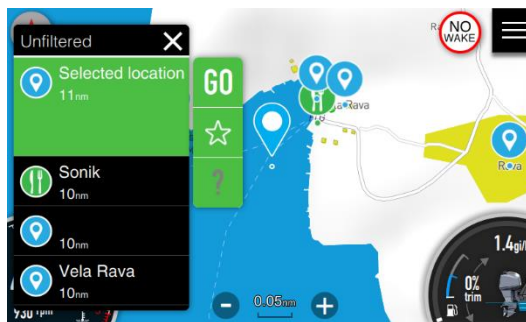

Press question mark to get more information about selected item.

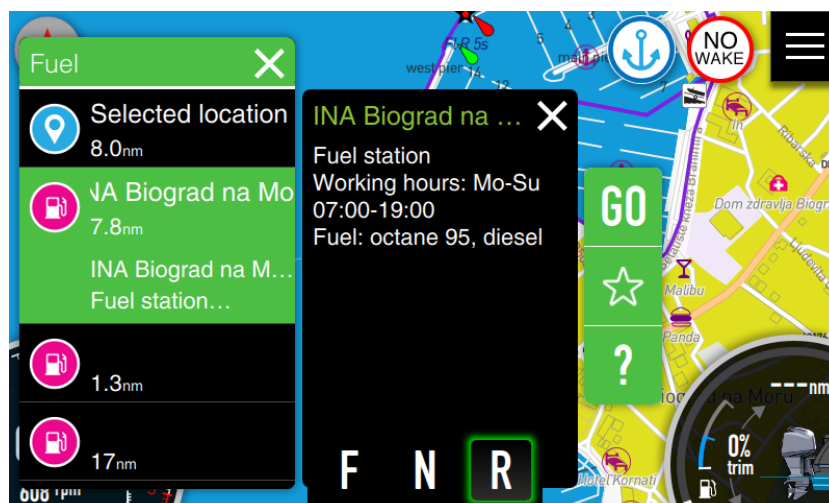

See chapter 7.1 for more details how to navigate to selected item.

6.1.3 Open sea map charts

OpenSeaMap is a software project collecting freely usable nautical information and geospatial data to create a worldwide nautical chart. This chart is available on the OpenSeaMap website, and can also be downloaded for use as an electronic chart for offline applications.

The project is part of OpenStreetMap. OpenSeaMap is part of the OpenStreetMap database, and complements the spatial data with nautical information. Such data may be used in accordance with the Open Database License.

The idea for the project was born at an OpenStreetMap developer conference in autumn 2008. A group of boaters and programmers decided to extend the coverage of OpenStreetMap to the seas and fresh water bodies. From the start the project has been worldwide and multilingual. By the end of 2009, the design and architecture of the project had been created, and a sample harbour "Warnemünde" was created to serve as an example chart. Since autumn 2009, a dedicated server has been available and the project is engaged in several collaborations with other free projects and organizations. In January 2010 OpenSeaMap was given a stand at boot Düsseldorf, Europe's largest boat show, allowing volunteers to present the project to a large audience of specialists for the first time.

6.1.4 Navionics charts

Navionics is an Italian manufacturer of electronic navigational charts. In 2017 Navionics was acquired by Garmin Ltd.

With the assistance of Garmin, Navionics has become the past, present and future of chart plotting and has been on an unimpeded path towards complete domination of the chart plotting industry since early 2018.



Some Navionics features require the most current data from Navionics. For those features, a message is displayed stating that the feature is unavailable if you do not have the appropriate Navionics charts or chart card inserted. For more information on what is required for these features, refer to www.navionics.com. You can also get a message if you try to use a restricted feature when the Navionics chart card is not activated. To activate the card, contact Navionics.

6.1.5 Selecting maps data

OpenSeaMap data are downloaded to device directly, whereas Navionics data must be installed by SD card. To manage maps data, go to the Home Screen>Settings>Maps. For OpenSeaMap select LXNAV maps menu item.

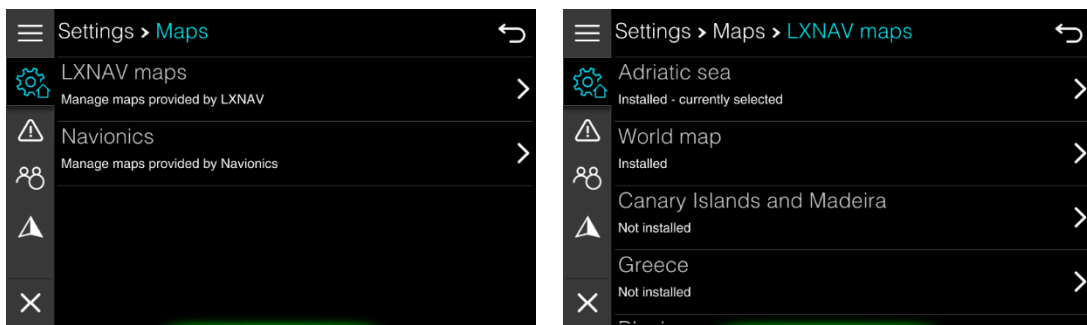

A list of all available maps data is shown together with indication, if it is installed or not. Selected item you would to manage. A new screen will open as shown on picture below.

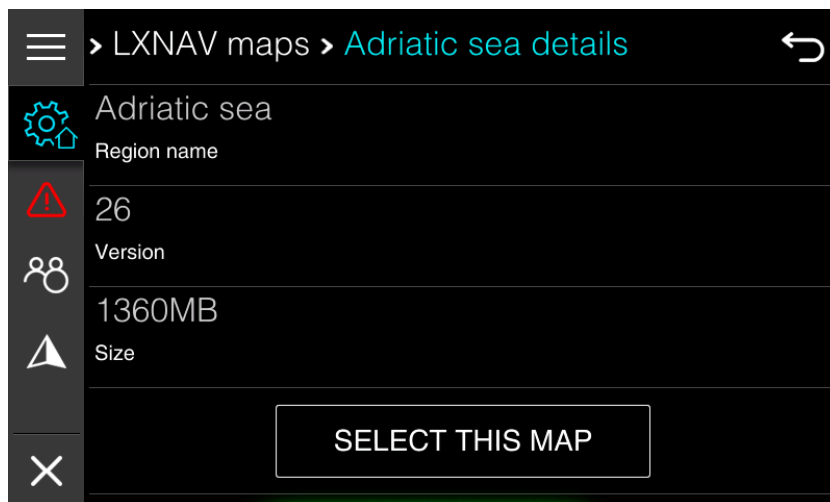

Press SELECT THIS MAP button to select this map data for all charts screen available in current profile. Press UPDATA or DOWNLOAD data, to update or download this map data. It is always recommended to have up to date maps data.

Navionics menu will show you basic information about installed Navionics map data. You can check your expire date here and you can also select this map as default for all available chart screens.

6.2 Chart settings

To change chart setting press home screen icon in top right corner and select arrow from main menu. Press Map Settings tab, if needed. Settings and display options made in the Chart settings page are done for last selected chart. Each chart is having its own settings.

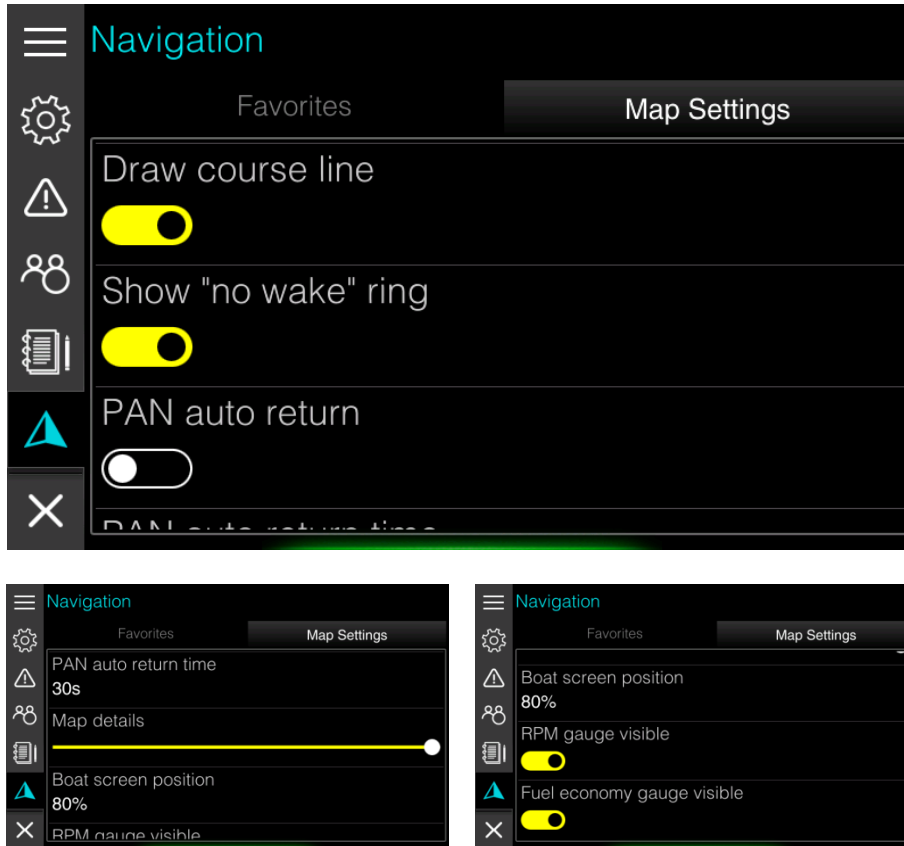

Following options are available as chart settings.

- | | |
|---|---|
| Draw course line | This will draw a course line from your boat in towards the direction boat is moving. |
| Show "no wake" ring | When close to coast, a red ring will be shown, indicating you distance from |
| PAN auto return /
PAN auto return time | If this option is enabled, chart will revert back to vessel position automatically once PAN auto return time will pass. |
| Map details | Map details slider gives you possibility to declutter your chart screen. If you move slider to the left side, less map data will be drawn on the chart screen and only most essential data will remain. |
| Boat screen position | You can move vessel position towards bottom of the chart screen. 50% setting means vessel location is in the middle of the |

screen and 100% means vessel location is at the bottom of the screen. It is recommended to have this setting around 70%.

RPM gauge

Enable or disable display of left RPM gauge.

Fuel economy gauge

Enable or disable right Fuel economy gauge.

7 Navigating

The navigation function allows you to navigate to the cursor position or to a waypoint via calculated route which takes into account all vessels limitations. Before you can start using this feature the boat draught, width and height must be entered into the system.

Do NOT rely on this device as your primary source of navigation.

User is responsible for using official charts and prudent methods for safe navigation. User assumes all liability for operation and associated risks. Navigation feature is based on electronic chart information. Data does not ensure obstacle and bottom clearance. Navigation and fuel functions are used for general planning only. They do not replace common navigational practices and should never be used as the only source of navigation.



Navigation may calculate routes that pass over land or shallow water.

Use visual sightings, and steer to avoid land, shallow water, and other dangerous objects.

7.1 Selecting a destination

Long press on a map will zoom in a map and a dialog showing points of interest and objects will open. A selected location is marked with a drop symbol. You can zoom in and zoom out using + and – symbol or pan a map to other location. Long press again to select different destination.

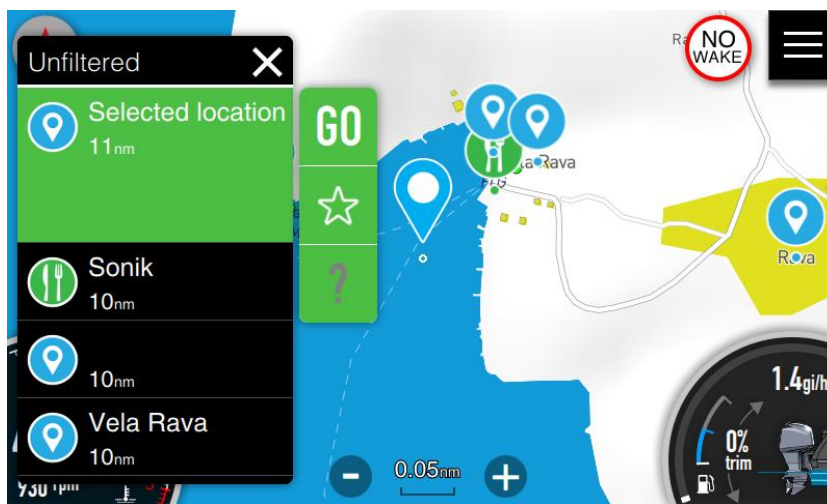

Header row indicates which filter is used for points. Press it to change filter. Press X to close dialog.

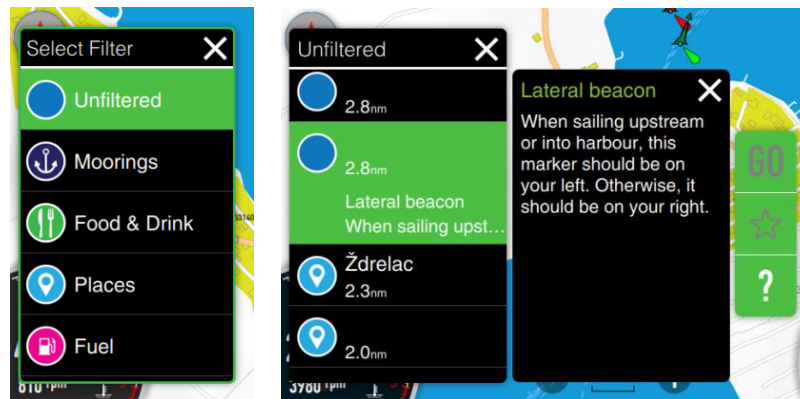

Press question mark to get more information about selected item. Star icon will add selected item to favourite list. A new dialog will open, where you can change name and add additional information for this item.

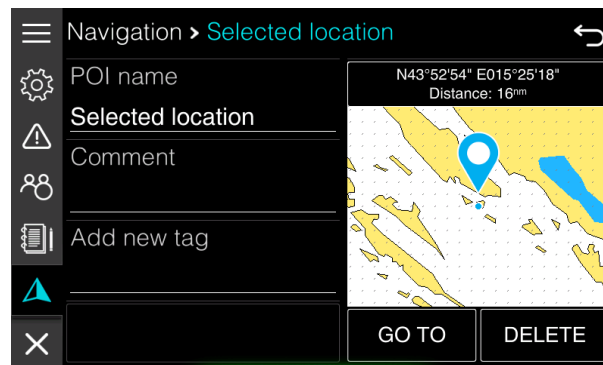

7.2 Selecting destination from favourites

You can also select a destination from your favorites list. Go to the Home Screen and select Navigation page. Select a destination from a list and press it.

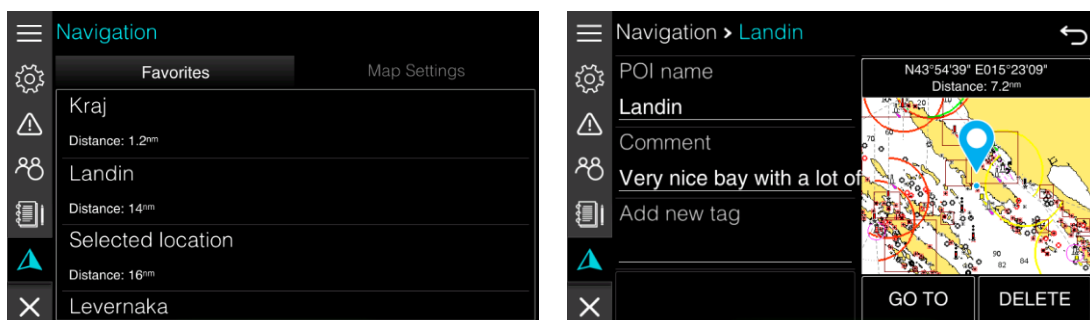

New dialog will open with more information about selected destination. Press GOTO button to start navigation to it.

You can also edit destination data here or delete it.

7.3 Navigating to destination

Press GO button to calculate route and start navigation to selected destination. Zoom will be changed so that you can see your vessel and selected destination on the screen. A dashed line connecting your vessel position with selected destination indicates that route is being calculated.

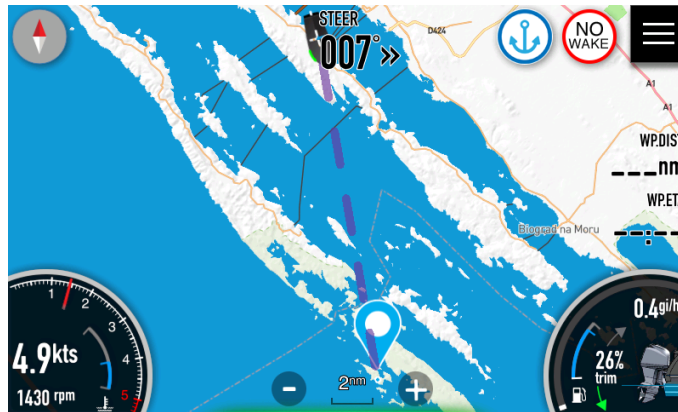

Once route has been calculated it will be displayed in green colour. Some parts of the route might be coloured red. This indicates parts of the route, where you will be close to the land and you should pay extra attention.

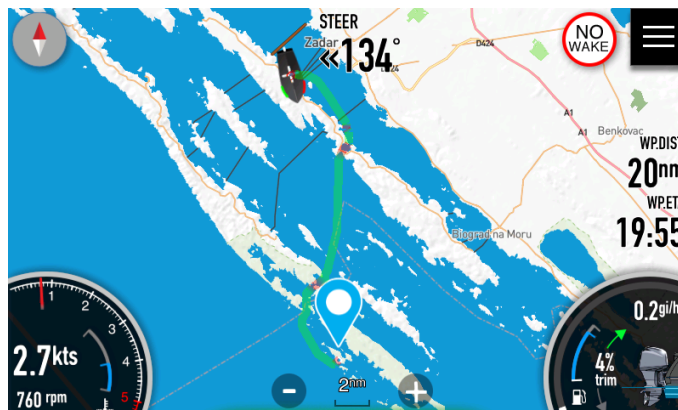

Screens are also showing three floating boxes for distance to destination, time arriving to destination and steering course. Please refer to Chapter 11.1 how to setup floating boxes.

7.4 Deleting route

If you would like to delete a route, long press on route itself. A menu as shown on a figure below will appear.

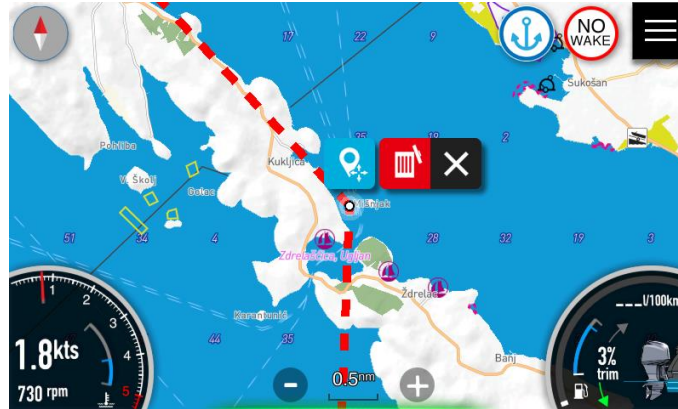

Press red trash bin icon. You will be prompted to delete a route. Once you confirm it, route will be deleted.

7.5 Adding intermediate points

For some reason, one might add intermediate points to your route. Press on route for long time to get a menu as for route delete option. Now move intermediate point to selected destination and press blue icon.

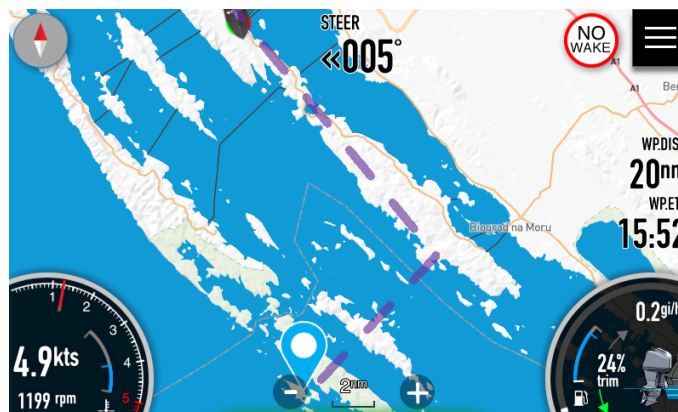

Dashed polyline from your vessel position via intermediate points towards final destination will be displayed. Once route is calculated, it will be displayed in green colour with all parameters recalculated.

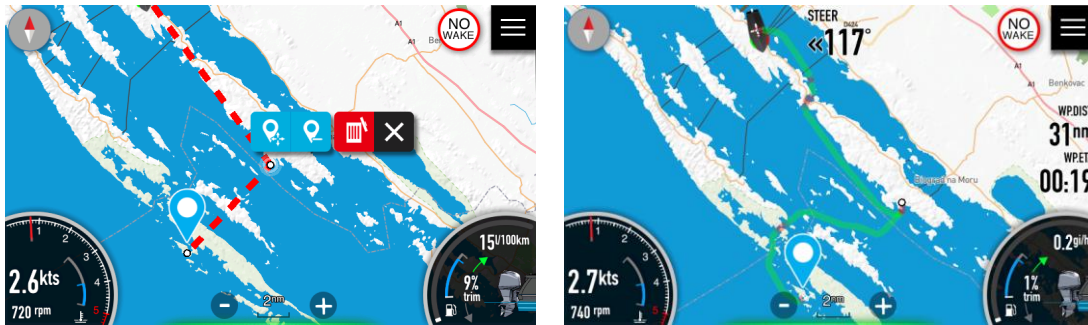

You can add more than one intermediate point

7.6 Delete intermediate point

You can delete an intermediate point if you long press on it. Additional blue icon will be shown on menu. Press blue icon with – symbol to delete an intermediate point.

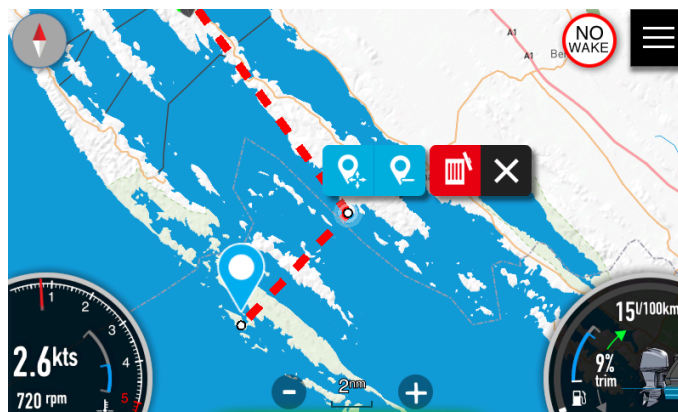

7.7 Reaching destination

Once you will get closer than 0.1nm to selected destination a message "Destination reached" will be displayed and route will be automatically delete.

8 Trip

Your device is recording past trip data in order to give an operator a feedback about vessel performance and usage. Trip statistics is focused on engine and engine parameters. On a trip screen, you can see following parameters.

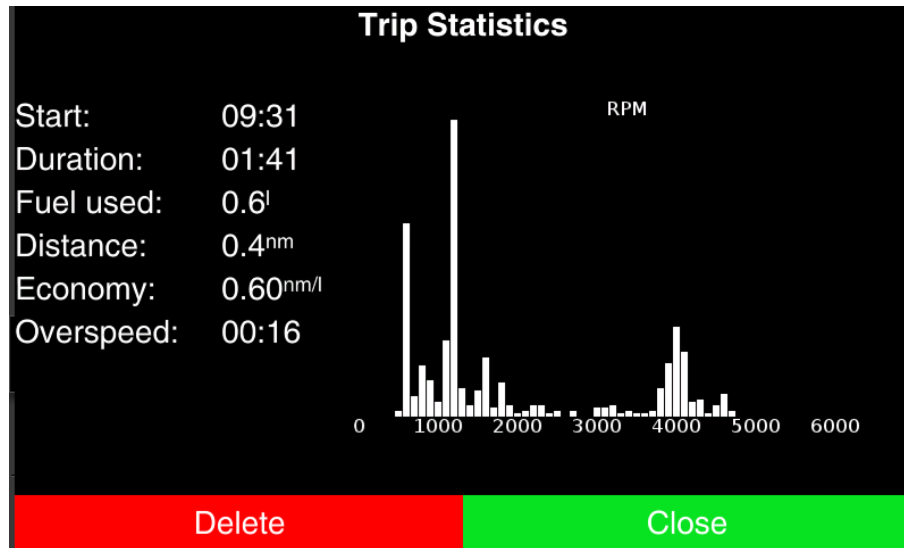

Start of current trip and its duration. Duration is taking into account only time, when engine was running. Fuel used during trip. Distance covered. Fuel Economy, which is calculated based on distance covered and fuel used during duration of this distance being done.

Overspeed time is time, when vessel was travelling about set high speed and above no wake zone speed.

Histogram on the right displays which RPM were used most of the time during the trip.

In the bottom line, red button will delete or reset selected trip statistics, Green CLOSE button will close trip screen.

Within the device three different trip statistics are available (User trip, logbook trip and owner trip statistics)

User trip

User trip is trip data, which can be reset by user. User can access this trip through the Quick Access page. Press Trip icon in shortcuts panel. A screen with user trip statistics will open.

Press RESET button to reset it or CLOSE button to close user trip statistics page.

Some data of user trip statistics are also visible in Fuel Economy dashboard screen. See Chapter 5.1 for more details, which data is visible there.

Logbook trip

Device is having an automatic logic or storing trips. This logic takes into account start time and position, pause time and other parameters to start and finish logbook trip. Logbook trips are available in the Home Screen, if you press Logbook icon in main menu.

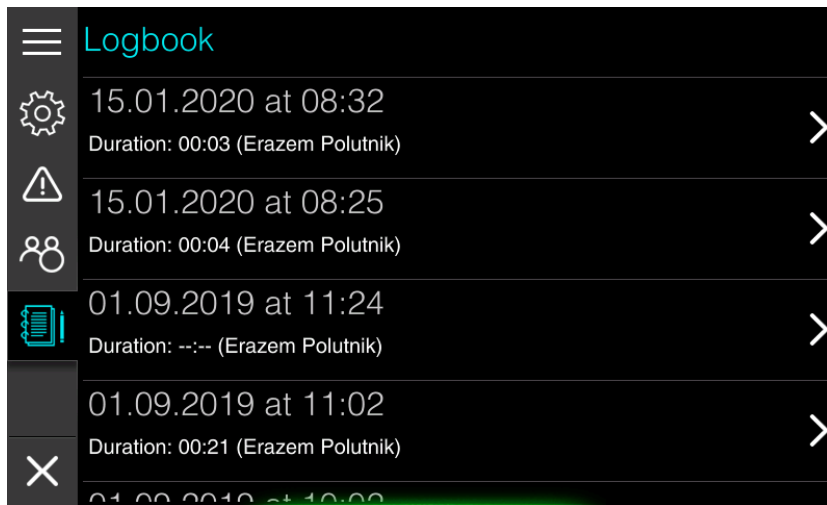

List of all logbook trips is shown there. Press on item, to get a trip statistics screen. Press DELETE button, if you want to remove selected trip for list. This action can not be revert and selected trip is lost forever.

Owner trip

This kind of trip data is available to vessel owner and is accessible through Owner mode in Settings screen. Owner mode is PIN protected, therefore only persons knowing pin can enter the menu. This option is designed for owners renting their vessels so that they can inspect trip statistics for selected renting period.

See chapter 12 for all the details about Owner mode.

9 Audio

If a FUSION marine entertainment system or compatible NMEA 2000 audio system is connected to the NMEA 2000 network, you can use the Ex00 device to control and customize the audio system on your vessel.

Select audio screenset from the Quick Access page. A screen as seen below will open.

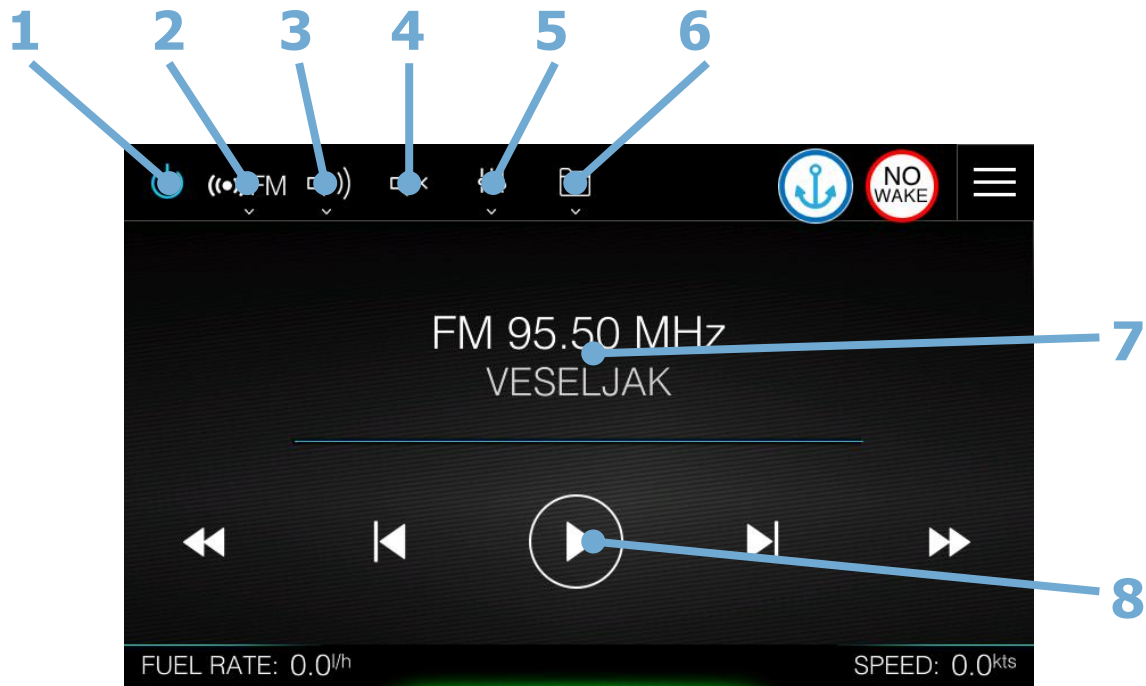

- 1 On/Off Audio
- 2 Audio source
- 3 Volume control
- 4 Mute audio
- 5 Audio mixer
- 6 Folder browser
- 7 Current station/music information
- 8 Play controls

Before you can start using your audio equipment, it must be installed according to the device installation manual and connected to the NMEA2000 network.

A compatible audio device connected to the NMEA 2000 network should automatically be identified by the system. If not, select it manually from network settings menu. See chapter 11.4 NMEA2000 Network for more details.

9.1 Audio source

Press the Audio source button and then select the audio source. Number of sources depends on the active audio device. Ex00 device supports FM radio, AM radio, Bluetooth and USB source.

9.2 Volume control

Volume control screen is used to control volume of your audio device.

Master volume control will sets the volume for all speaker zones at the same time.

Separate zones volume can be increase or decrease individually with corresponded zone slider.

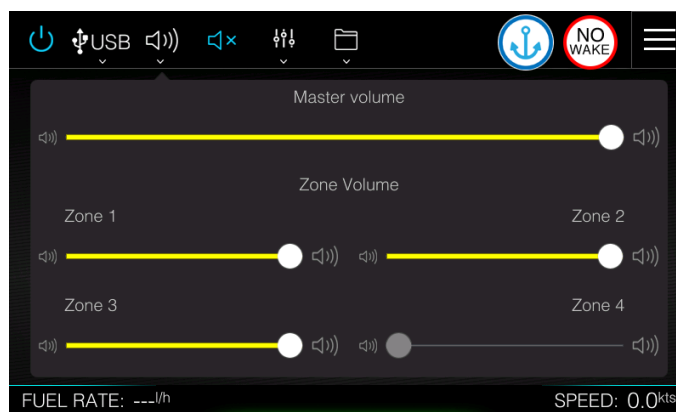

Number of zones may vary from audio device to audio device

Press mute icon to mute audio instantly. When radio is muted, icon will be in blue colour.

Repressing it will restore volume level to previously set level.

9.3 Audio Mixer

Use the Audio Mixer to adjust the balance, bass and treble for selected zone.

The Audio Mixer options vary depending on the activated audio device.

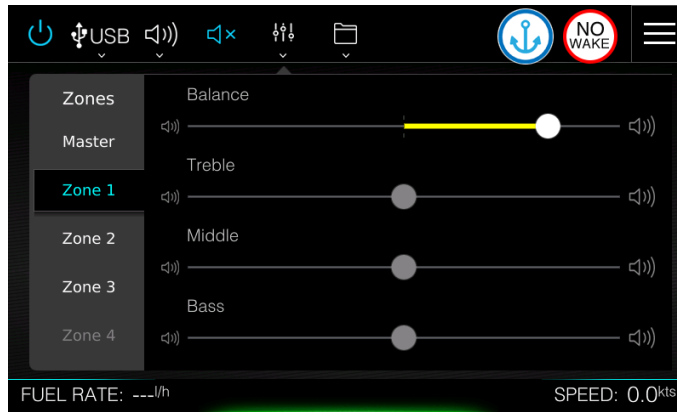

9.4 Folder Browser

When selected source is USB you can browse your storage device to find music.

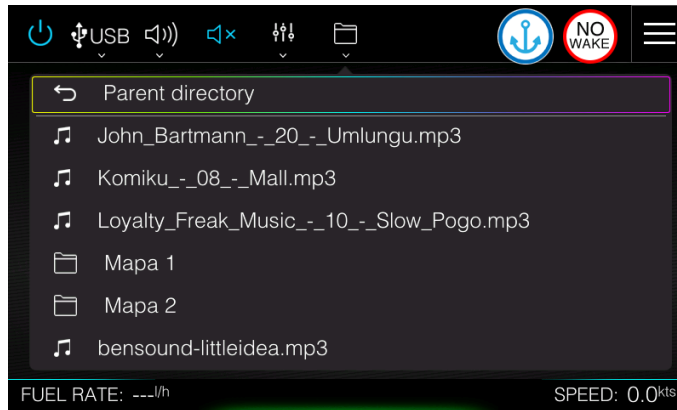

9.5 Current station/music information

Current station panel displays information about selected frequency on the radio and channel name, if available. When playing music from USB storage device or Bluetooth, song name is shown with time progress.

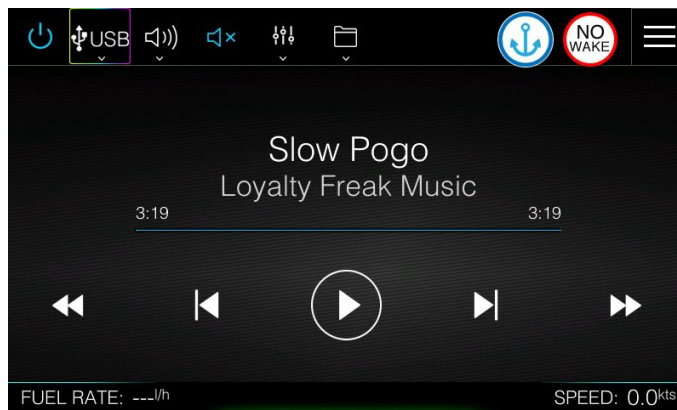

9.6 Play controls

Display of current station music being played varied slightly based on source. Use the controller buttons to control your audio system.



When playing music from USB or BT most left and most right button will fast forward or backward current song. Inner two forward and backward buttons will move to next/ previous song. Press middle button to toggle play or pause.

When playing radio, middle button is not used. Inner forward and backward button are used for channel scan and will stop at nearest radio station. Outer buttons are used for frequency scan.

10 Connectivity

E-series devices are having a Wi-Fi module built-in. It is used for device updates, maps data update, maps data download and debug reporting. To select a Wi-Fi network or to configure your preferences regarding Wi-Fi, please go to Settings>Connectivity menu.

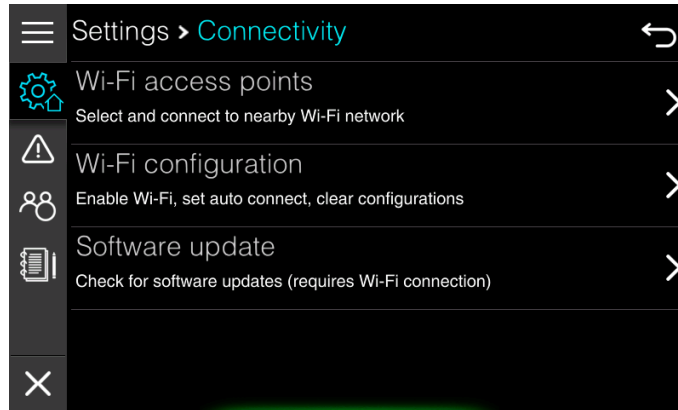

10.1 Wi-Fi access points

Select this menu to see list of all available Wi-Fi access points. Click on the selected Wi-Fi access point and enter required password if needed. After that press CONNECT button and device should established a connection with selected network.

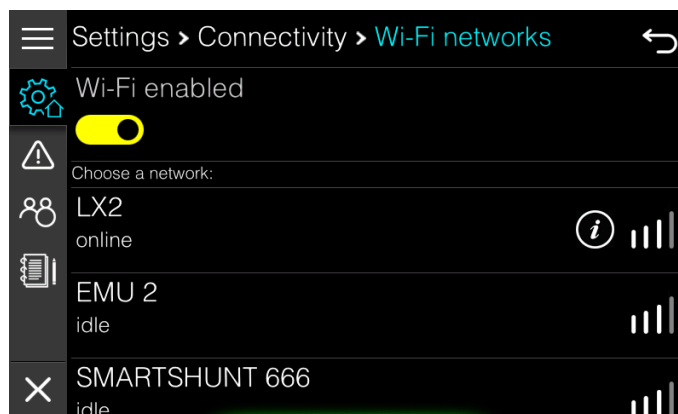

If you are already connected a round icon with letter i will be shown next to signal strength. Press it, to get information about IP address assigned to the device.

You can also completely disable Wi-Fi with a switch at the top of the page. Sometimes, if no access points are found, it is recommended to switch off Wi-Fi and re-enable it after few seconds.

10.2 Wi-Fi Configuration

You can enable auto connect functionality in this menu. When auto connect functionality is enabled, device will automatically connect to the strongest known Wi-Fi access point.

When automatic connect is enabled, device will also automatically check for new firmware upgrades. If upgrade is available an operator will be asked for it.

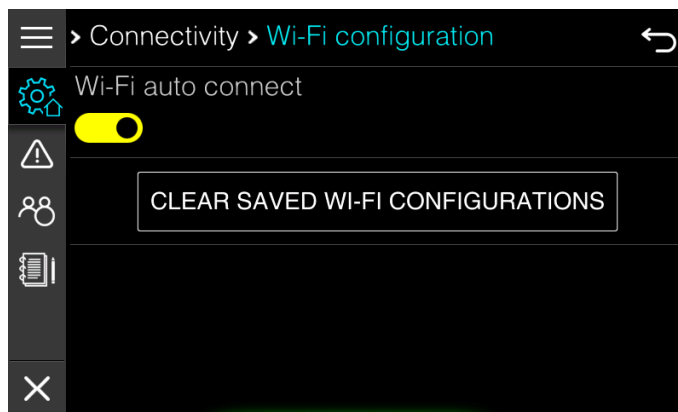

Press CLEAR button to delete all stored Wi-Fi access point configurations.

10.3 SOFTWARE update

Device can be updated only through the Wi-Fi connection. In this menu you can check for the latest version. Two update channels are available Stable and Beta channel. You can change update channel with password 02929.

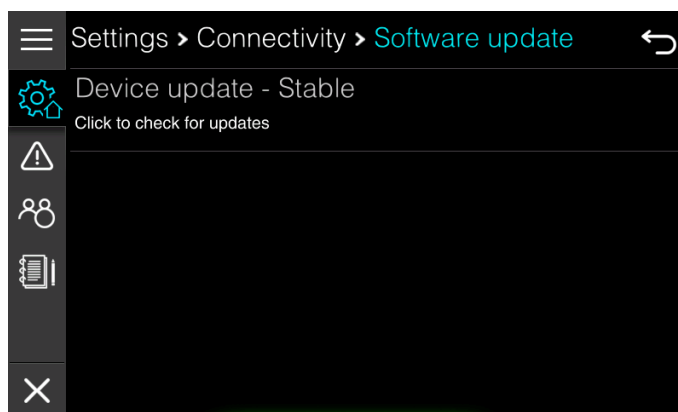

Press Device update to start update procedure. If new update is available, you will be prompted to continue. Follow the instructions on the screen to complete t



If the update procedure is interrupted, device might be unusable afterwards.

11 Customizing your system

E-series device is capable of customisation at different levels.

It is possible to customize all screens on your device except the Home screen. You can add to any screen a numerical parameter, which are grouped together in a box, which we are calling floating box. You can add as many floating boxes as you want to. Background, Text size and colour can be customised for each floating box separately. This is going to be described in chapter 11.1 Floating boxes.

You can create your own dashboard screens with different parameters being displayed on them. You can combine screens into your own screenset, which is stored in your profile on the device. You will learn more about Screens and Screensets in chapter 11.2.

Profiles are used, when different users are operating this device. Each user will have own preferences setting, screens and screenset selection. Management of profiles is explained in chapter 11.3.

In case there are several data sources available on the NMEA2000 network you can select source that suits you. You can also customize parameters for engine, depth sensor, battery monitoring settings and much more. These settings are meant for vessel owner or very experienced person and should not be modified or changed by normal user. How to do this is shown in chapter 11.4.

11.1 Floating boxes

Floating box is a group of numerical parameters, which you can add to any screen of device. To start editing or adding floating boxes, first select a screen, where you would like to edit, add or delete a floating box. Now press the Home menu icon in top-right corner. This will bring you the Quick Access page. Press Edit FloatBox icon in shortcuts panel. Previous screen will open and you will notice two new icons in top right corner with a symbol + and x.



Press X to close FloatBox edit mode. These two icons will change back to the Home icon.









11.1.1 Creating new floating box

Press + to add new floating box. New floating box with single parameter (depth) will be created on the right side of the screen, together with the dropdown menu.



Dropdown menu

Dropdown menu is having following options.

-  Add a new numerical parameter to the floating box.
-  Move floating box around the screen.
-  Decrease the font size.
-  Increase the font size.
-  Change font colour black or white
-  Enable or disable black transparent background
-  Remove the floating box
-  Close editing of selected floating box.

Selecting parameter

Newly created floating box will have only one numerical value, which is going to be depth. To change it, press on the value itself. A new dialog will pop up with all possible choices.



Select your desired parameter from the list. By default all possibilities are shown, if you would like to get a filtered view, press on top row (Unfiltered) and select a filter from a list of choices (unfiltered, engine, fuel, trip, vessel status, environment, route, time and battery).

Adding parameter

Same dialog will be shown if you add a numerical parameter to the floating box. Press + icon from the dropdown menu, to add new numerical parameter to the floating box.

Delete a parameter

If you want to delete a parameter from the floating box, slide selected parameter to the right. Red remove area will be shown on in the item itself. Press it to remove selected parameter.

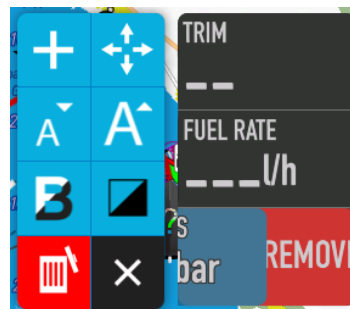

11.1.2 Moving the floating box

Press  icon to move floating box on the screen. When you press it, arrow cross will appear on the floating box and you can start moving floating box on the screen.

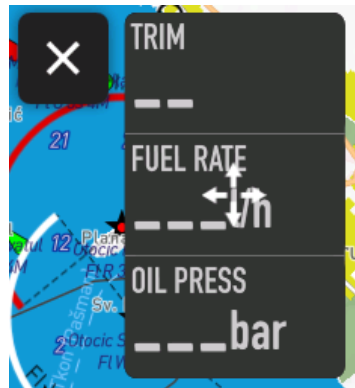

11.1.3 Edit floating box

If you want to start editing a floating box and you do not see a dropdown menu, press and hold on a floating box until dropdown menu does not appear.

11.1.4 List of parameters

VESSEL STATUS	Steering course	Engine alter. poten.
Compass deviation	WP distance	Engine boost press.
Compass heading	WP ETA	Engine cool. press.
Distance from coast	WP ETE	Engine gear
GNSS course	WP fuel usage	Engine load
GNSS latitude	WP name	Engine rpm
GNSS longitude	MISC	Engine temperature
GNSS quality	Black water level	Engine torque
GNSS satellites	Black water volume	Engine tot. hrs.
GNSS speed	Fresh water level	Engine trim
Pitch	Fresh water volume	Oil pressure
Rate of turn	Oil level	Oil temperature
Roll	Trim tabs port	BATTERY
Vessel speed	Trim tabs starboard	Battery 1 amp hours
Water ref. speed	FUEL	Battery 1 current
Yaw	Curr. fuel volume	Battery 1 SOC
Bus voltage	Fuel economy	Battery 1 SOH
TRIP	Fuel economy 60sec	Battery 1 temp.
Trip distance	Fuel range	Battery 1 time remain.
Trip economy	Fuel rate	Battery 1 voltage
Trip fuel used	Meas. fuel volume	Battery 2 amp hours
TIME	Total fuel used	Battery 2 current
Current date	ENVIROMENT	Battery 2 SOC
Current time	Air temperature	Battery 2 SOH
Sunrise time	Water depth	Battery 2 temp.
Sunset time	Water temperature	Battery 2 time remain.
ROUTE	ENGINE	Battery 2 voltage

11.2 Screens and Screensets

Device consists of the Home screen and other application screens, which are grouped into screensets. New device is being shipped with three predefined screensets; dashboard, map and audio screenset. You have learned about these three screensets in Chapter 3.1. In next chapters it will be described, how you can create your own screens and screensets. All the management of screens and screen set is done in Settings>Screen menu item.

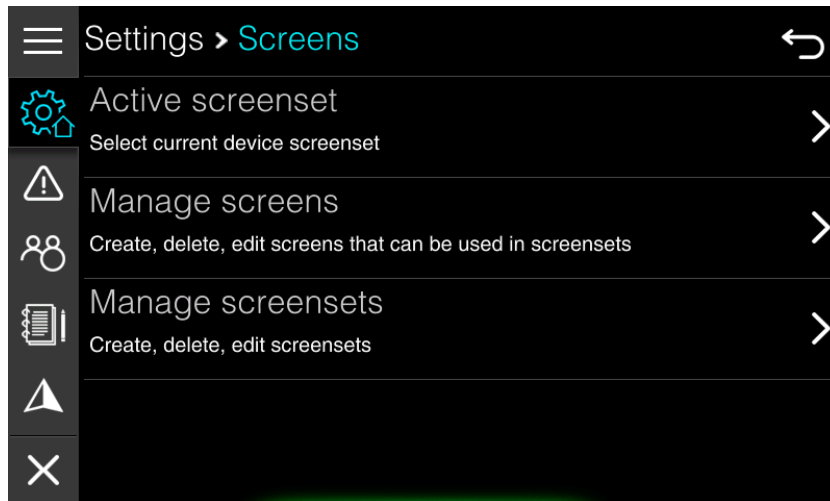

11.2.1 Screensets

A screenset is composed from one or more screens, which you can toggle so that you swipe with your finger from left to right or right to left. Number of screens in a screenset and which screen is currently active is indicated by small dots at the bottom of the screen.

Select active screenset

To select an active screenset select it from the Quick Access Page from screenset panel or choose Active screenset option in above menu. A list of available screensets is shown. To create a new screenset, edit existing screenset or delete a screenset select Manage screensets item in menu. New menu will open with options to edit, delete or add a screenset.

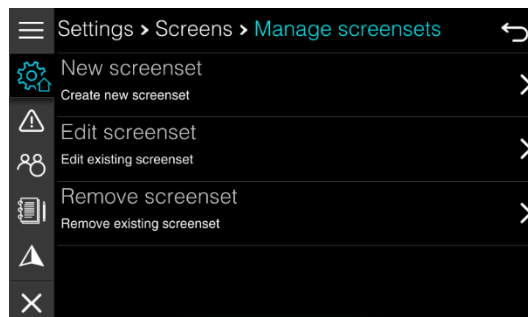

New screenset

To create a new screen select New screenset item from the menu. A new window will open with parameters for new screenset.

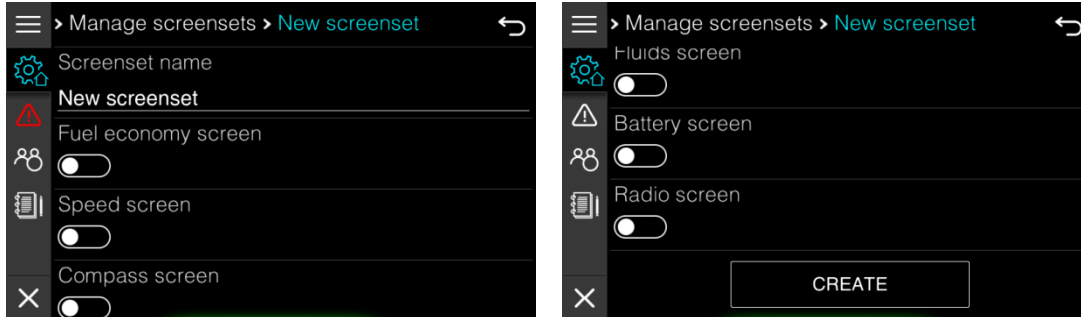

Enter the screenset name first. A screenset name must be at least four characters long. This is name is shown on the list of screensets.

Below the name there is a list of all available screens in the application. Select screens you would like to include to newly created screenset.

Once you are finished press create and new screenset is done and ready to use.

Edit screenset

It is also possible to edit a screenset. Select Edit screenset item and select a screenset you would like to edit. Do not forget to press SAVE CHANGES at the bottom of the edit screenset dialog to save changes.

Delete screenset

To delete a screenset press Remove screenset item. A list with all the available screensets is shown. Select a screenset you would like to remove. Confirm removal and screenset will be erased.

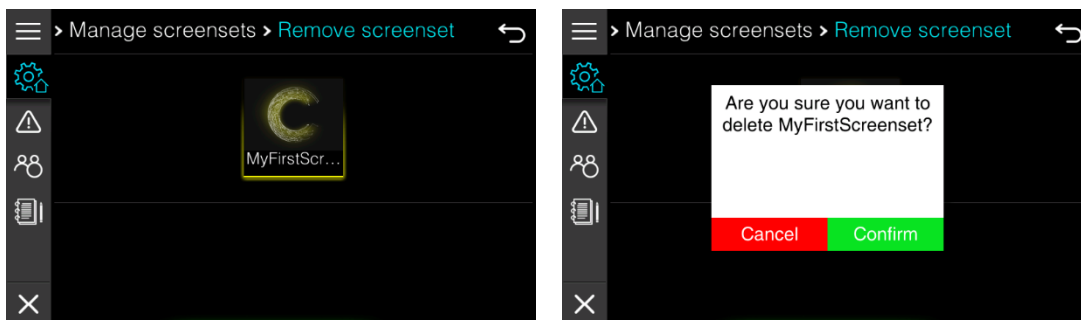

You may notice that default "system" screensets" are not visible in edit screenset selection and delete screenset selection. There is done intentionally as we do not want operator to delete them or rename them.

11.2.2 Screens

The application is composed of different screens, which are grouped together into a screenset. There are three screen types available. Dashboard screens are showing one big numerical value in the middle of the display with some additional gauges for engine parameters. Map screen shows a chart and Audio screen is used to control you externally connected audio device. All these screen types can be modified to the certain extent.

To manage screens select Manage screens item in Screens settings menu. You will be able to add new screen, edit existing one delete a screen.



All newly created screens or modified screens are linked to the current profile and are not visible to other profiles.

Create new screen

Select this item, if you would like to create a new screen. A dialog will open with a template for new screen. First you have to enter screen name and then you have to select screen type.

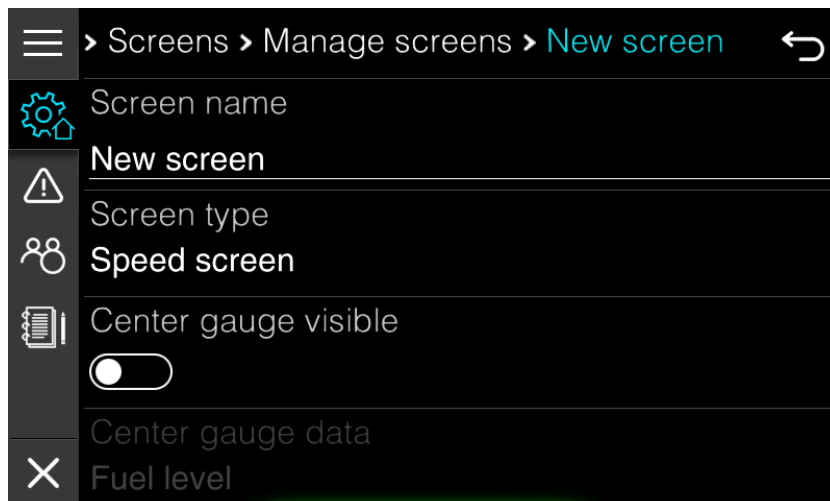

It is possible to select among following dashboard templates: speed screen, position, fuel economy screen, depth screen, fluids screen, battery screen, trim screen and rudder screen. You can also select map screen template or audio screen template.

Customization options vary depending on screen type. More details about dashboard screen options were given in chapter 5.

For map screen you can only select a map source, which can either be LXNAV charts or Navionics chart.

Press CREATE button, once you are finished with customization to create a new screen.

Edit screen

It is also possible to edit existing screens. A list of all available screens is shown first. Select a screen, you would like to edit.

You will notice that also all default dashboard screens are available for edit. When editing these screens, you cannot change screen type. The application needs all these screens for IAssist functionality, therefore you cannot change screen type, but you can customize it.



Default map screens are not shown as there is no option for customization. One default map screen is created for OpenSeaMap charts and one for Navionics charts.

Delete screen

To delete a screen select Delete screen option. A list of user created screens will be shown, as default screens cannot be deleted. Select a screen you would like to delete and confirm removal of screen.

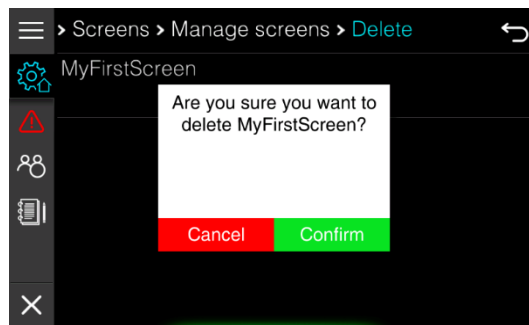

11.3 Profiles

When more than one operator is using this device, it is possible to create an individual profile for each of operator. In a profile all user preferences are stored including custom made screens and screensets.

You can select, edit, add or delete a profile in the Home Screen if you select Profile icon from the main menu.

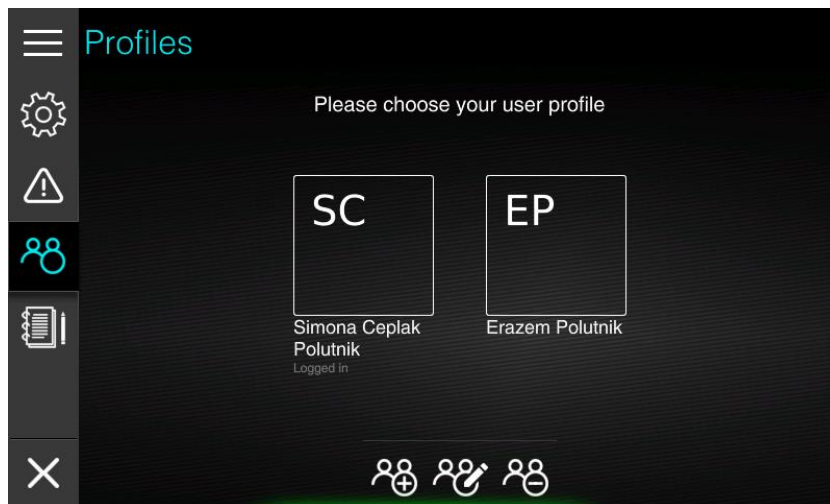

A list of profile is shown in boxes with initials. A full name of profile is printed below the box. The profile, which is currently being used in identified with Logged in label below the name.

Select profile

To select a profile, simple press on the profile box, you would like to use. Profile will get rainbow border and once a profile is successfully loaded, screen will change to default screen for this profile.

If more than one profile is available during start-up, operator will be prompt to select a profile before disclaimer screen is shown.

Add profile

In the bottom of the screen three icons are drawn. Select most left one with + to add a new profile. A wizard for profile creation will start.

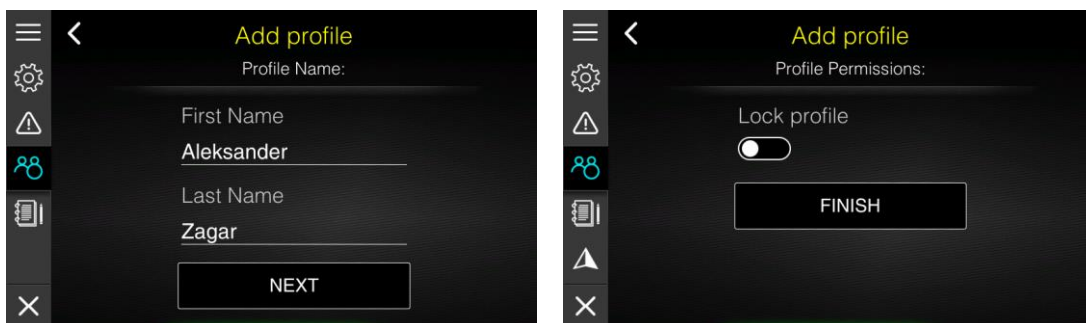

Enter name of profile owner and press NEXT button. Profile can also be locked.

Lock profile

When profile is locked, all changes made to screen, screensets and preferences are lost once instrument is switched off. It is recommended to do complete setup of your profile including all custom-made screen and screensets.

Once you are satisfied with your profile, you should lock a profile. This will guarantee you that profile will be the same each time you start the device.

Edit profile

Profile name and lock option can also be changed at later time. Press middle icon with pencil. All profile boxes will change colour to light blue. Select a profile you would like to edit and a screen with profile name will be shown. Press next to change lock option for this profile.

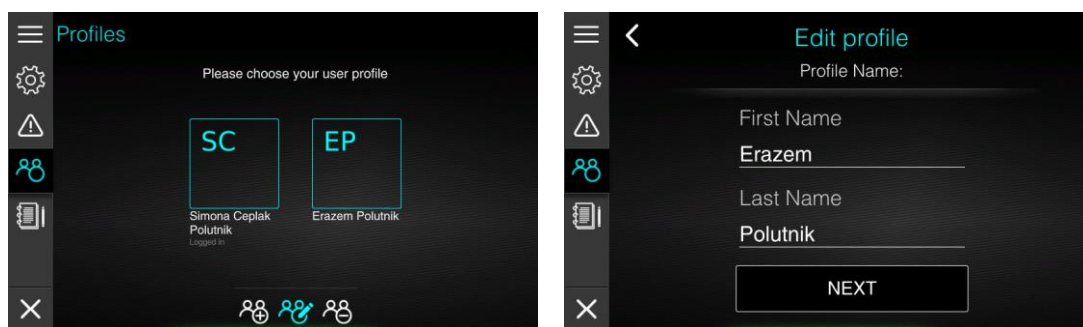

Delete profile

Profiles can also be deleted. Press right icon with – sign. All profile boxes will turn red. Select a profile, you would like to delete. A confirmation message is shown. Once this message is confirmed, profile will be deleted permanently and this action cannot be recovered.

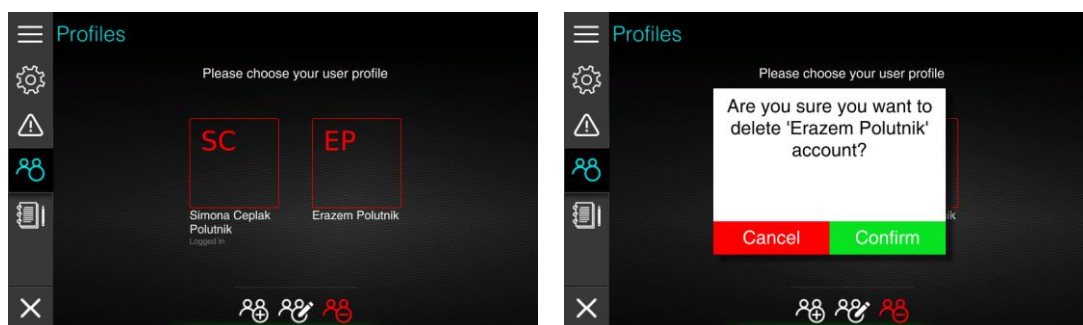

Profile, which is currently being use cannot be deleted. To delete this profile you have to select another profile first and then delete it.

11.4 NMEA2000 Network

E-series device should be connected to the vessel NMEA2000 network. Once it is connected to the network, it will become a part of it and it will be capable of reading data from other participants of the network.

Network menu is used to configure data sources, to get additional information about participants and to make calibration of specific data sources.



Use this menu with special care as modification done in this menu might cause device not to behave correctly and thus it will make a system unusable.

11.4.1 Connected devices

Select connected devices menu item to get list of all connected devices to the network. You may be asked to send us some information from this menu, if a device, which you would like to use as a source for specific parameter is not recognized.

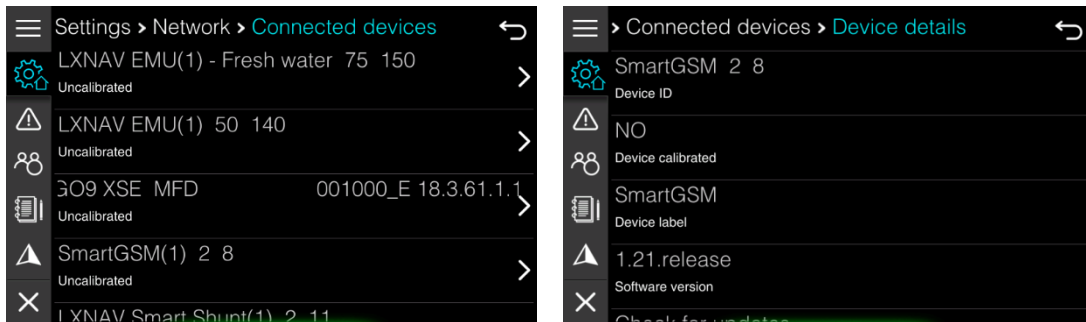

Select a device to get more details about it. At the bottom of the device details, there is an option to reset configuration for this device. This will delete all configurations previously done for this device and device will behave as being seen for the first time.

Externally connected devices manufactured by LXNAV will have an option to upgrade software. Select item Check for update to update it and follow instructions given.

A physical device can also have several virtual devices presented to the network. You can see these virtual devices, if you press Virtual devices item.

11.4.2 Data sources

In this menu you can define data sources for various parameters. You can select a source for jogwheel, engine, depth, water referenced speed, GPS, inside temperature, outside temperature, water temperature, fuel level, oil level, fresh water level, black water level, rudder, audio, compass, trim tabs, batteries and electrical powertrain source.

By default, all items are set to Auto Select, which means that the source will be assigned automatically based on network participants.

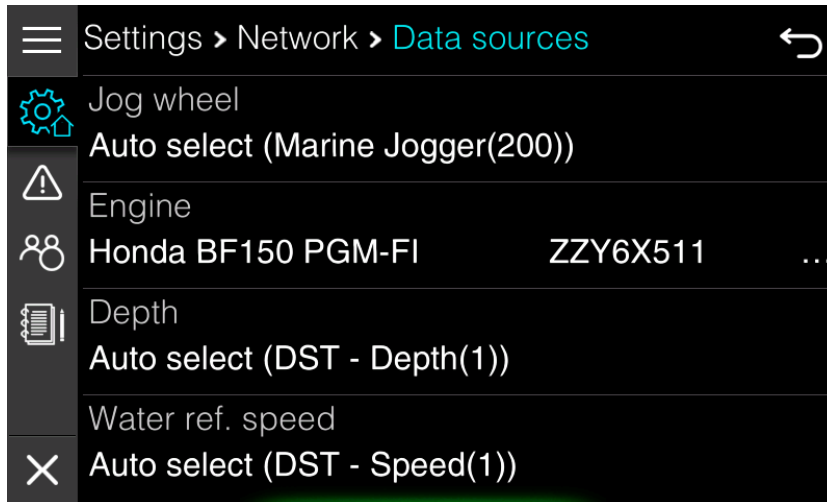

If you want to select it manually, press on selected source and scroll through available selection. If you explicitly do not want to use this data, set it to NONE.



If there is no fuel level sensor installed a virtual fuel tank be selected as a source for fuel. When virtual fuel tank is selected only calculated fuel will be available in the application.

11.4.3 Device calibration

Some of the devices connected to the network may require a calibration. For example, you have to specify temperature limits for engine or maximum rpm for engine. These calibration parameters are later used for data rendering. A list of all possible calibration groups is shown in this menu. Some of the calibrations are stored internally in E-series devices and some of the calibrations are sent to the externally connected device.



Select a group, where you would like to do a calibration. A list of all available devices for this group will be shown. Select a device, you would like to calibrate.

Engine calibration

Inside engine calibration you can set engine temperatures minimum and maximum, engine coolant pressure limits, oil pressure and temperature limits and maximum engine RPM. Based on these settings, engine gauges are rendered.



You can also change the name of the device to more familiar name. This is particular useful, if more devices with same name are connected to the network.

Depth calibration

For a depth sensor you can define an offset here. Have in mind this offset is used only on this device and settings in not forwarded to depth sensor itself.

Fluid level calibration

Sometimes it is required to do a more precise fluid level calibration as it not linear over whole range of the sensor. This calibration is used only on this Ex00 device and is not forwarded to the sensor itself.

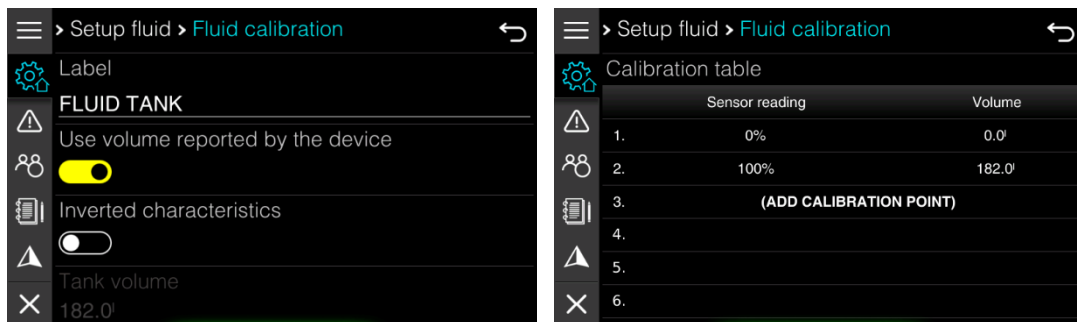

Some fluid level devices are reporting volume capacity by themselves. Use option "Use volume reported by the device" to automatically read tank capacity from device.

If this option is not enabled, enter proper size of tank.

Sometimes fluid level sensors are having reverse reporting. Selected "Inverted characteristics" in this case.

It is also possible to add calibration points. By default only two calibration points are given and they cannot be modified. 0% means empty tank 0l and 100% means tank capacity.

Add up to ten calibration points to make fluid level readings more precise. Press "Add calibration point" button. A dialog with current sensor reading and current fluid volume will be display. Modify one or both parameters according to your measurements. Press Save Changes to confirm this new point. If you want to delete a calibration point, tap it and select delete option form the open dialog.

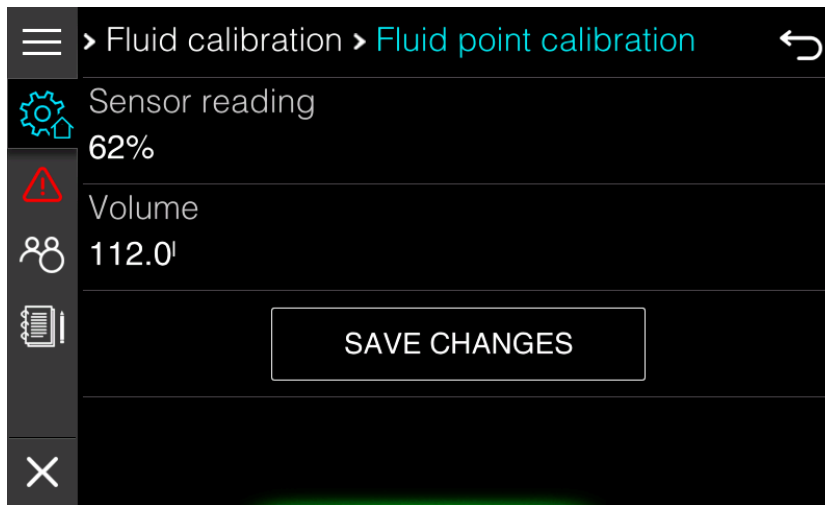

Rudder angle calibration

Rudder sensor can be calibrated in this menu. Press CALIBRATE button and follow instructions given on the screen.

Jogwheel calibration

Jogwheel is having a built-in beeper. You can enable/disable a beeper inside Jogwheel in this menu and set loudness of the beeper.

Battery calibration

If a battery monitoring device is connected to the system such as SmartSHUNT, you can specify in this menu basic parameters about chemistry of the battery and its parameters. This data is sent to battery monitoring device, if it is supporting standard NMEA2000 battery configuration packet.

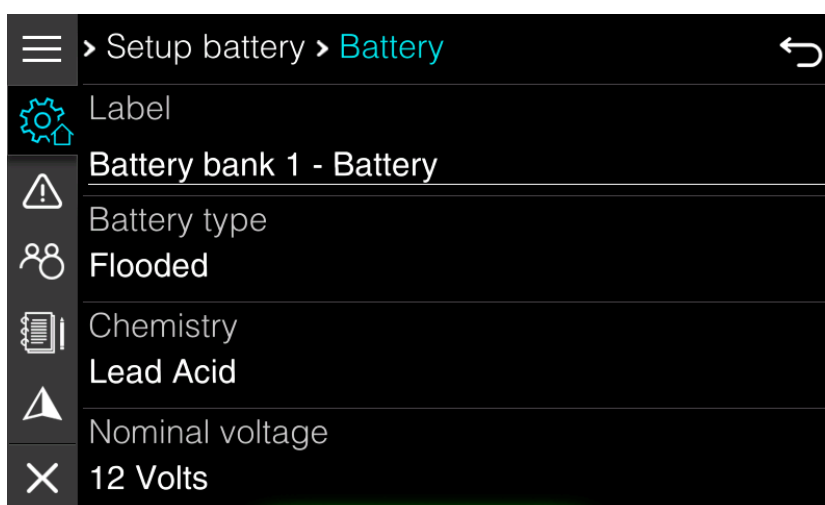

11.5 Password

Password is used to open or unlock some of the menus, which are not designed to be used on daily basis and are there for advanced users only.



Changing parameters of selection options on screens, which are visible under password, may change behaviour of your device. Use these menus with great care and only, if you are familiar with it.

Following passwords are available.

- 02929** Select your update channel, which can be beta or stable
- 44441** System menu. In system menu, you can enable demo mode, change parameters for IAssist, upload debug reports, enable screenshots and test some of the hardware functionality.
- 30000** This password will open dialog for activation code. If not complete functionality is available for your device and you have received an activation code for selected functionality, use this password to enter activation code
- 00666** System reset. Select options, which you would like to reset to default.

12 Owner mode

Owner mode is very special function of E-series device designed for vessel owners, which are renting out vessel to other people. Owner can quickly restore device setup and view statistics for last rent of a vessel.

Owner mode is pin protected. Default pin for owner mode is 1234 and can be changed in owner mode setup. To access owner mode go to Home Screen>Settings>Owner mode. First you will be prompt for a pin.

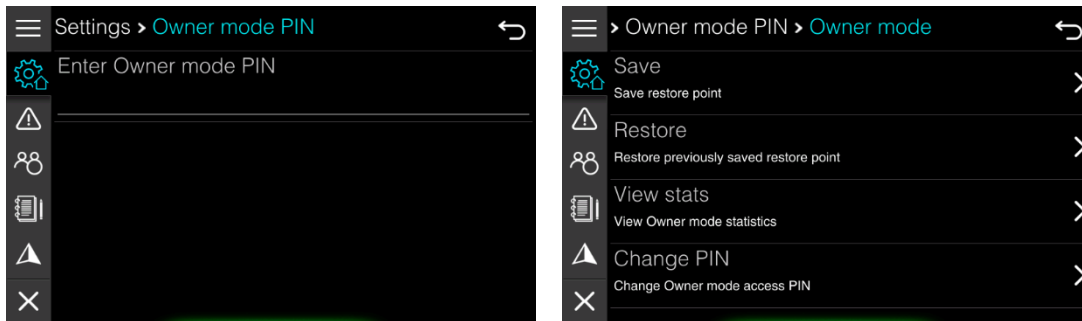

Once a pin is entered owner mode menu will open. You can set or recall a restore point here, view owner mode statistic and change PIN for the owner mode.

12.1 Restore point

In order to set a restore point, SD card must be inserted into the device. Make a full configuration of your device, including NMEA2000 connected devices, screen and screensets and profile.

Save restore point

Once your system is completely configured, press SAVE option. A confirmation dialog will be shown. When you confirm it, restore point is saved to your SD card.

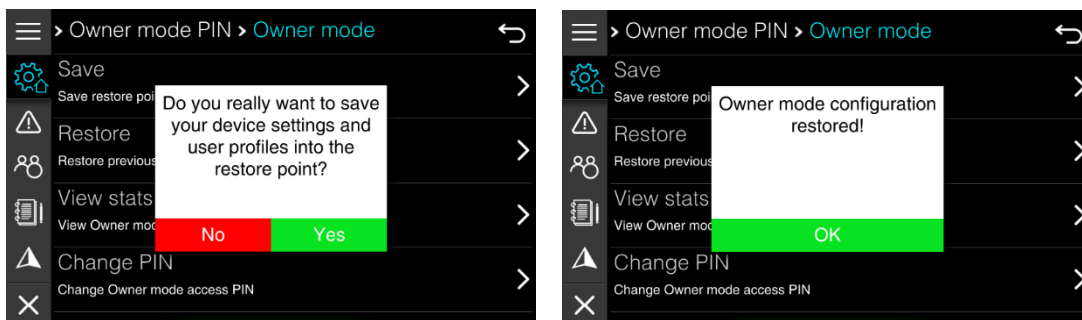

Only one restore point is saved to the SD card. If you have previously saved a restore point to SD card, it will be overwritten with new restore point.



You can use SD card with restore point also on other device of same type. This function is very useful for boat builders to configure device, with a single click.

Restore device

Press Restore button to restore device to the stored restore point. A message with some basic info about restore point will be displayed. Once you have confirmed this message, device will be restored.

Do you really want to restore your device to previously saved restore point?

Current restore point:

saved ..T at :T
on device with serial number "13"



12.2 Statistics

Owner mode statistic will have same parameters as any other trip statistics. The only difference is that it is available only to the owner and only owner can reset it. Press View Stats button to get to the statistics page. All details about parameters given in statistics page are described in Chapter 8 Trip.

12.3 Owner mode pin

To change owner mode pin select Change PIN option. Once new pin is confirmed, you can start using it. Write it down as it cannot be recovered.

13 Using jogwheel

The Jog wheel has several actions:

- Rotation of 360° (for selection and switching purposes)
- Press button (for confirmation, cancel purposes)

If you want to change a parameter (in the set-up), you should press the Jog wheel to enter the EDIT menu where you can modify parameters by the following:

- text control
- selection control
- slider control
- check boxes
- spin control



Rotating the Jog wheel will change between device modes.

14 Maintenance

The unit does not contain any field serviceable components. Therefore, the operator is required to perform only a very limited amount of preventative maintenance. It is recommended that you always fit the supplied protective sun cover when the unit is not in use.

Cleaning the display unit

A proper cleaning cloth should be used to clean the screen, where possible. Use plenty of water to dissolve and take away salt remains. Crystalized salt may scratch the coating if using a damp cloth. Apply minimal pressure to the screen. Where marks on the screen cannot be removed by the cloth alone, use a 50/50 mixture of warm water and isopropyl alcohol to clean the screen. Avoid any contact with solvents (acetone, mineral turpentine, etc.), or ammonia-based cleaning products, as they may damage the anti-glare layer. To prevent UV damage to it is recommended that the sun cover be fitted when the unit is not in use for an extended period.

Creating debug report

In very unlikely case of device firmware problems, it is possible to send us a report, where we will learn more about difficulties you have experienced. To send us a debug report, please connect your device to a network, enter password 44441, select Log management item and press Upload logs button.

15 Specifications

15.1 Mechanical/Environmental specification

E500 Mechanical/Environmental

Casing	aluminium
Operating temp	-25°C to +60°C
Water ingress	IPX6
Weight (excluding mounting hardware)	290 g
Screen brightness	1200 nits
Screen resolution	800 x 480 (W x H)
Viewing angle in degrees	L/R: 70, top: 50, bottom: 70
Dimensions (overall)	See dimensioned drawings

E500 Electrical

Operating voltage	12 - 28 V DC
Current draw at 12V (max. backlight)	0,48A (LEN 10)
Low power standby mode	yes
Protection	reverse polarity
Processor	Quad-core ARM Cortex-A7 CPU
Conformity	CE

E500 Interfaces

NMEA 2000 (compliant)	1 port (Micro-C male)
microSD card reader	1x microSD
USB	yes

E700 Mechanical/Environmental

Casing	aluminium
Operating temp	-25°C to +60°C
Water ingress	IPX6
Weight (excluding mounting hardware)	600 g
Screen brightness	1200 nits
Screen resolution	800 x 480 (W x H)
Viewing angle in degrees	L/R: 70, top: 50, bottom: 70
Dimensions (overall)	See dimensioned drawings

E700 Electrical

Operating voltage	12 - 28 V DC
Current draw at 12V (max. backlight)	0,55A (LEN 11)
Low power standby mode	yes
Protection	reverse polarity
Processor	Quad-core ARM Cortex-A7 CPU
Conformity	CE

E700 Interfaces

NMEA 2000 (compliant)	1 port (Micro-C male)
microSD card reader	1x microSD
USB	yes

E900 Mechanical/Environmental

Casing	aluminium
Operating temp	-25°C to +60°C
Water ingress	IPX6
Weight (excluding mounting hardware)	950 g
Screen brightness	1200 nits
Screen resolution	1024 x 600 (W x H)
Viewing angle in degrees	L/R: 70, top: 50, bottom: 70
Dimensions (overall)	See dimensioned drawings

E900 Electrical

Operating voltage	12 - 28 V DC
Current draw at 12V (max. backlight)	0,90A (LEN 18)
Low power standby mode	yes
Protection	reverse polarity
Processor	Quad-core ARM Cortex-A7 CPU
Conformity	CE

E900 Interfaces

NMEA 2000 (compliant)	2 port (Micro-C male)
microSD card reader	1x microSD
USB	yes

15.2 Dimensional drawings

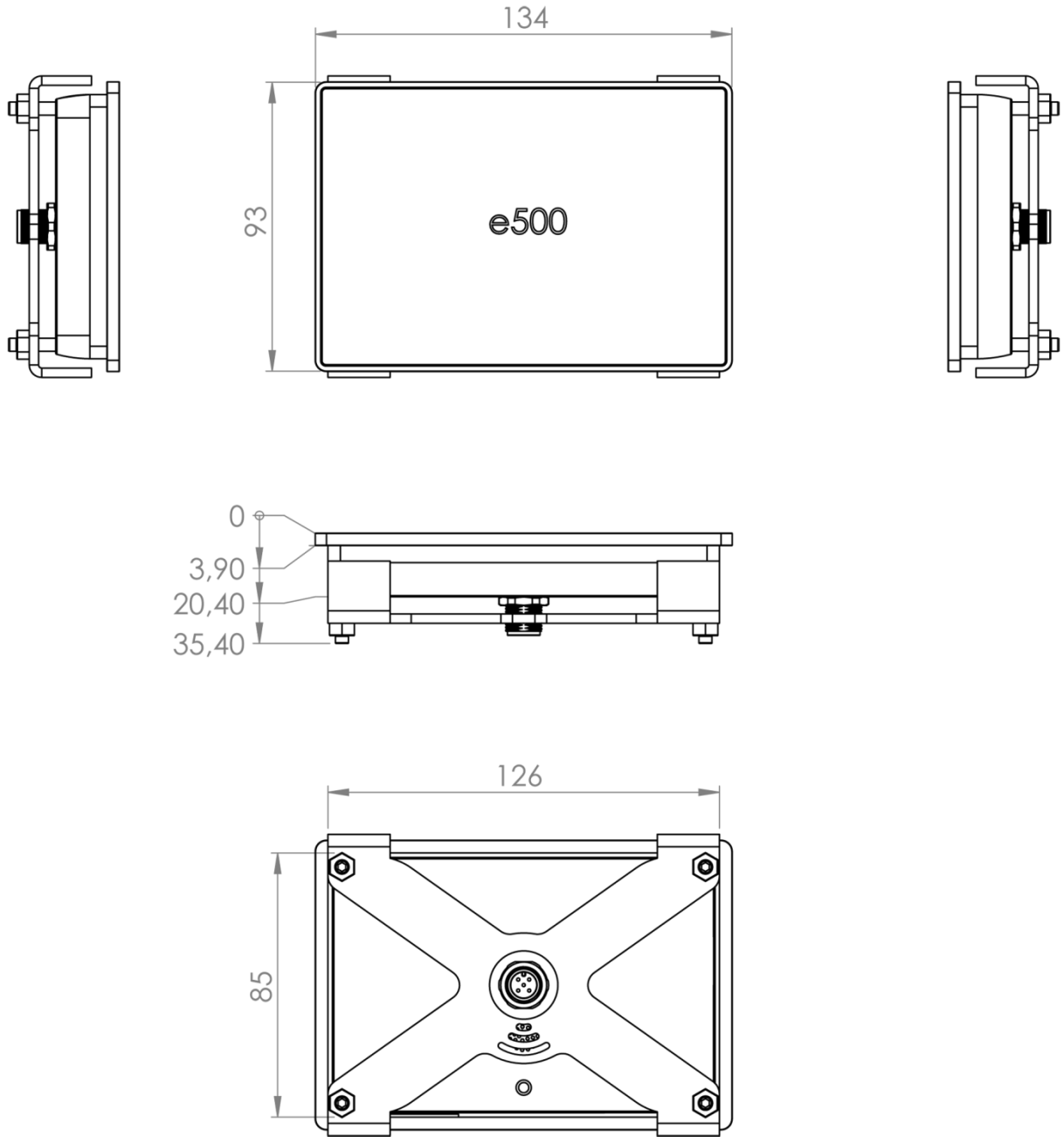

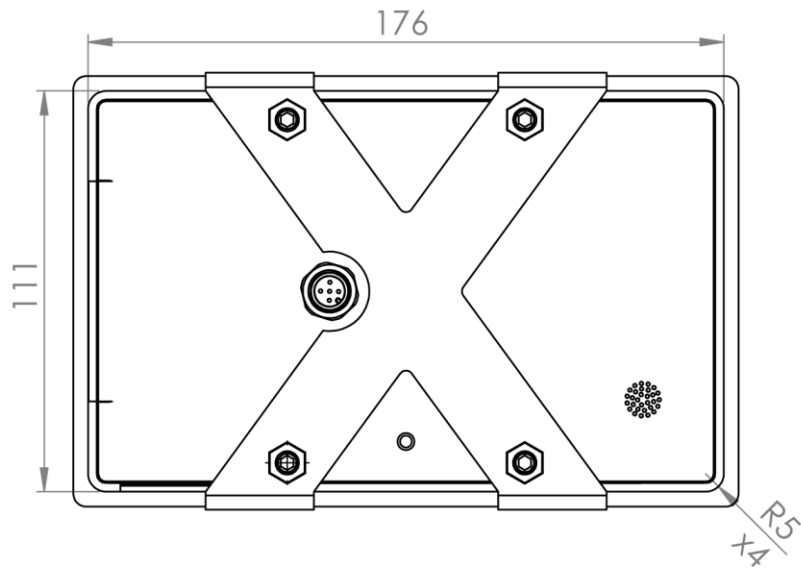
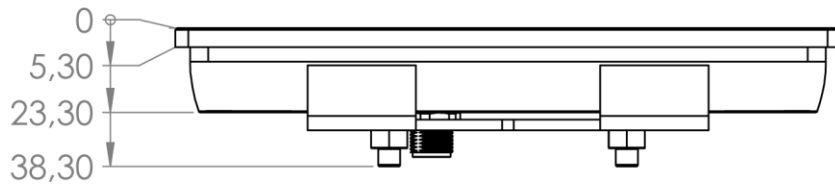
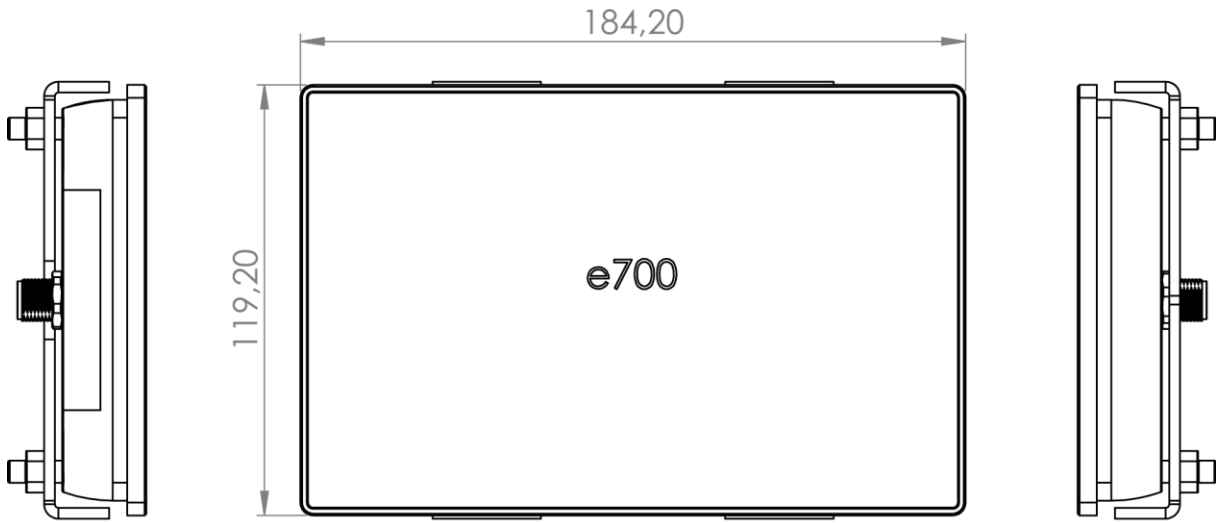

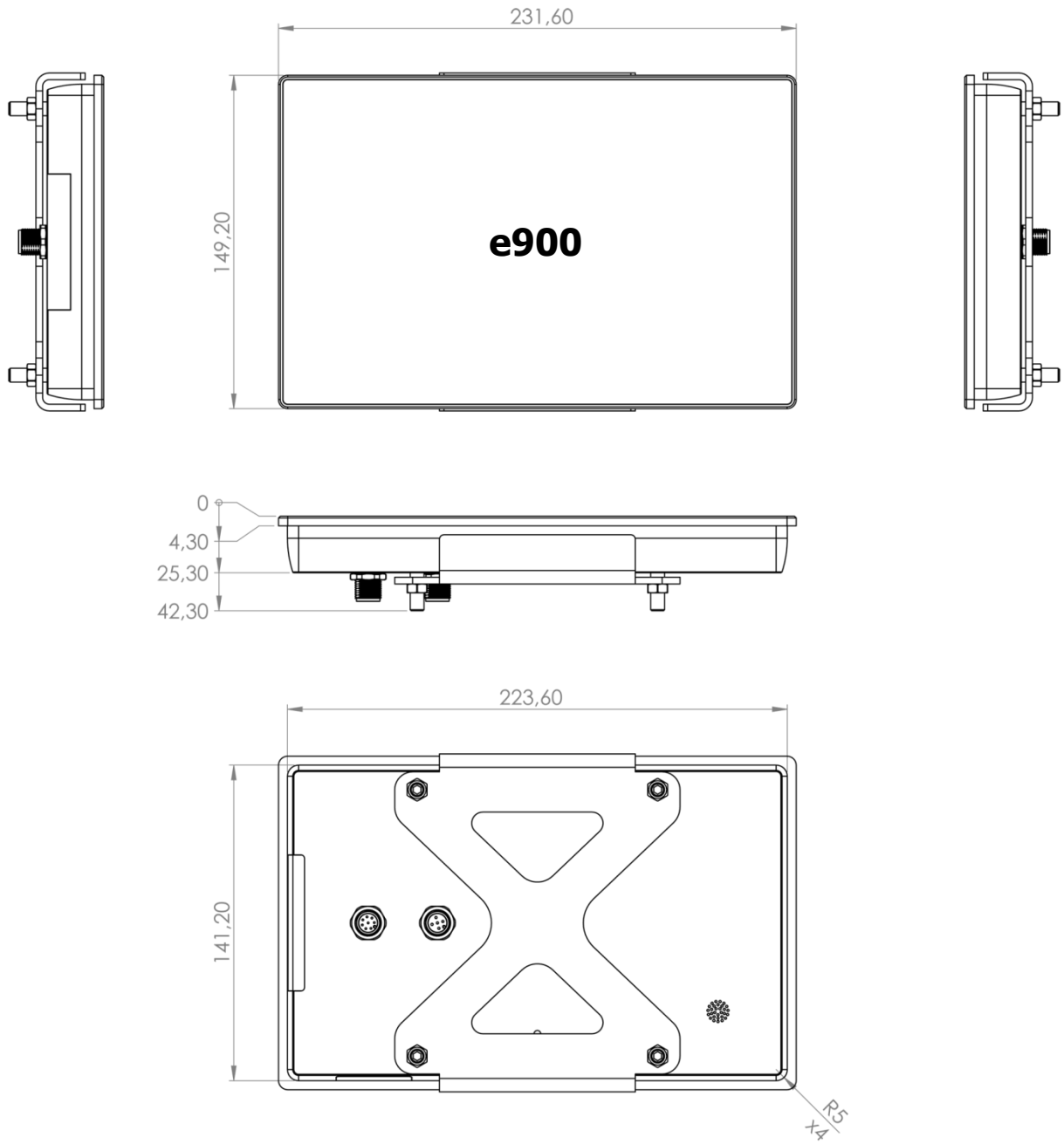

15.3 Supported data

NMEA 2000 compliant PGN List

NMEA 2000 PGN (transmit)

59392	ISO ack
59904	ISO request
60160	ISO transport protocol - data transfer
60416	ISO transport protocol - command
60928	ISO address claim
61184	ISO proprietary a
65280	ISO proprietary b
126208	Group function
126464	PGN list
126720	ISO proprietary a2
126996	Product information
127505	Fluid level
130825	Proprietary LXNAV message fast broadcast

NMEA 2000 PGN (Receive)

59392	ISO ack
59904	ISO request
60160	ISO transport protocol - data transfer
60416	ISO transport protocol - commands
60928	ISO address claim
61184	ISO proprietary A
65280	ISO proprietary B
65311	Evinrude iTrim
126208	Group function
126720	ISO proprietary A2
126983	Alert
126996	Product information
127245	Rudder
127250	Vessel heading
127251	Rate of turn
127257	Attitude
127258	Magnetic variation
127488	Engine parameters, rapid update
127489	Engine parameters, dynamic
127493	Engine transmission parameters
127497	Trip fuel consumption, engine
127505	Fluid level
127506	Dc detailed status
127508	Battery status
127513	Battery configuration status
128259	Speed, water referenced
128267	Water depth
129026	COG & SOG, rapid update
129029	GNSS position data

129539 GNSS DOPs
129540 GNSS satellites in view
130310 Environmental parameters 1
130311 Environmental parameters 2
130312 Temperature
130569 Entertainment - current file and status
130570 Entertainment - library data file
130571 Entertainment - library data group
130572 Entertainment - library data search
130573 Entertainment - supported source data
130574 Entertainment - supported zone data
130576 Trim tab status
130580 Entertainment - system configuration status
130581 Entertainment - zone configuration status
130582 Entertainment - zone volume
130584 Entertainment - Bluetooth devices
130585 Entertainment - Bluetooth source status
130816 Proprietary multipart broadcast
130820 Fusion server message
130825 Proprietary LXNAV message fast broadcast
130884 Proprietary LXNAV raw fast broadcast

16 REVISION HISTORY

Rev	Date	Comments
1	February 2020	Initial release of this manual
2	December 2020	Corrections to English language text.



LXNAV d.o.o., Kidričeva 24, SI-3000 Celje, Slovenia EU
+386 592 33 400 | info@lxnav.com | marine.lxnav.com | shop.lxnav.com